

electriQ

AIRCUBE[®]

PORTABLE AIR CONDITIONER
DEHUMIDIFIER, HUMIDIFIER
AIR PURIFIER

USER MANUAL

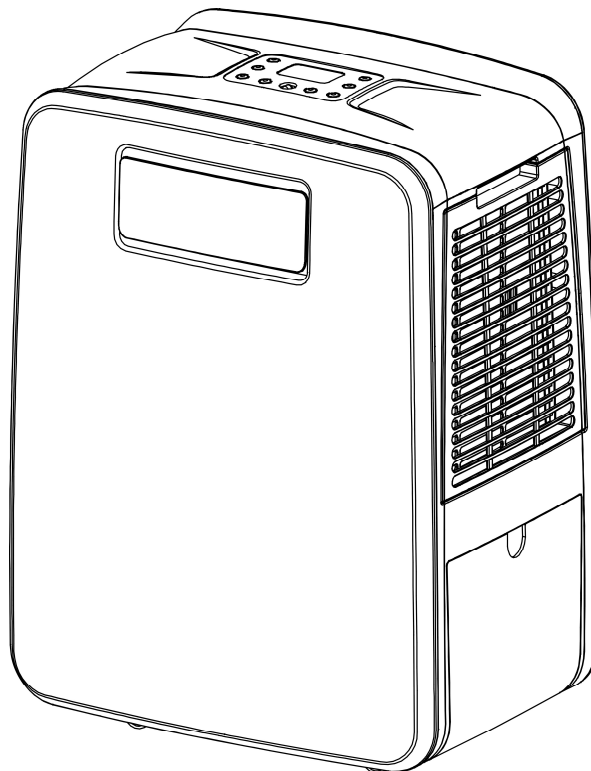

Thank you for choosing ElectriQ

**Please read this user manual before using this innovative appliance
and keep it safe for future reference**

Visit our page www.electriQ.co.uk for our entire range of Intelligent Electricals

CONTENTS

1. SAFETY INSTRUCTIONS	3
2. FEATURES AND PARTS LIST	4
3. INSTALLATION	5
4. OPERATION AND SETTINGS	7
5. WATER-DRAINAGE	12
6. MAINTENANCE	13
7. TROUBLESHOOTING	14
8. APPENDIX	15

SAFETY INSTRUCTIONS

Important!

- Carefully read the instructions before operating the unit. **Note:** This appliance is for indoor use only.
- Rating: This unit must be only connected to a 220-240 V / 50 Hz earthed outlet.
- Installation must be in accordance with regulations of the country where the unit is used.
- If you are in any doubt about the suitability of your electrical supply have it checked and, if necessary, modified by a qualified electrician.
- This appliance has been tested and is safe to use. However, as with any electrical appliances - use it with care.
- Disconnect the power plug from socket before dismantling, assembling or cleaning.
- Avoid touching any moving parts of the appliance.
- Never insert fingers, pencils or any other objects through the guard
- This appliance is not intended for use by persons (including children) with reduced physical, sensory or mental capabilities. It is also not intended for use by those with a lack of experience and knowledge, unless they have been given supervision or instruction concerning the use of the appliance by a person responsible for their safety.
- Do not leave children unsupervised with this appliance.
- Do not clean the unit by spraying it or immersing it in water.
- Never connect the unit to an electrical outlet using an extension cord. If an outlet is not available, one should be installed by a qualified electrician.
- Never operate this appliance if the cord or plug is damaged. Ensure the power cord is not stretched or exposed to sharp object/edges.
- A damaged supply cord should be replaced by the manufacturer or a qualified electrician in order to avoid a hazard.
- Any service other than regular cleaning or filter replacement should be performed by an authorized service representative. Failure to comply could result in a voided warranty.
- Do not use the appliance for any other purposes than its intended use.
- **This unit must always be stored and transported upright, otherwise irreparable damage may be caused to the compressor; if in doubt we suggest waiting at least 24 hours before starting the unit.**
- Avoid restarting the air conditioning unit unless 3 minutes have passed since being turned off. This prevents damage to the compressor.
- Never use the mains plug as a switch to start and turn off the air conditioning unit. Use the provided ON/OFF switch located on the control panel.
- Always place the unit on a dry and stable surface.
- The appliance should not be installed in laundry or wet rooms

Energy Saving and Unit Safety Protection Tips

- Do not cover or restrict the airflow from the outlet or inlet grills.
- For maximum performance the minimum distance from a wall or objects should be 50cm. Unit is fitted with thermal cut off sensor that will prevent overheating
- Keep the filters clean. Under normal conditions, filters should only need cleaning once every 2-3 weeks (approximately). Since the filters remove airborne particles, more frequent cleaning maybe necessary, depending on the air quality. Remove the HEPA filters for maximum cooling and dehumidifying performance. Wash the mesh filters and gently vacuum clean the HEPA filters
- For the initial start-up in air conditioning mode set the fan speed to maximum and the thermostat to 3-4 degrees lower than the current temperature. After, set the fan switch to low and set the thermostat to your desired setting.
- To protect the unit we recommend not using the cooling function when the ambient temperature > 35°C.

FEATURES AND PARTS LIST

1. Features

- Part of ElectriQ AirCube® range of Intelligent Air Conditioning products
- Compact, designer inspired model
- Cooling, Dehumidifying, Humidifying and Air Cleaning for year round use
- Improves comfort and indoor air quality
- Dual stage HEPA filters for efficient Air Cleaning (optional)
- Self-evaporative system in cooling mode - no need to empty external water tank
- Digital Control Panel with side vents to prevent dust and dirt entering the machine.
- Intelligent LCD screen, indicates temperature, humidity, operation mode
- Remote control that can be stored in slot on the side of unit after use.
- The hot air outlet is positioned high on the unit – this allows for improved performance with the use of a short hose
- On/Off timer function – allows you to choose when the unit operates both in air conditioning and dehumidifying mode
- Advanced Compressor protection technology
- Recessed castors for improved portability
- Self-Diagnostic intelligent appliance

2. Parts list:

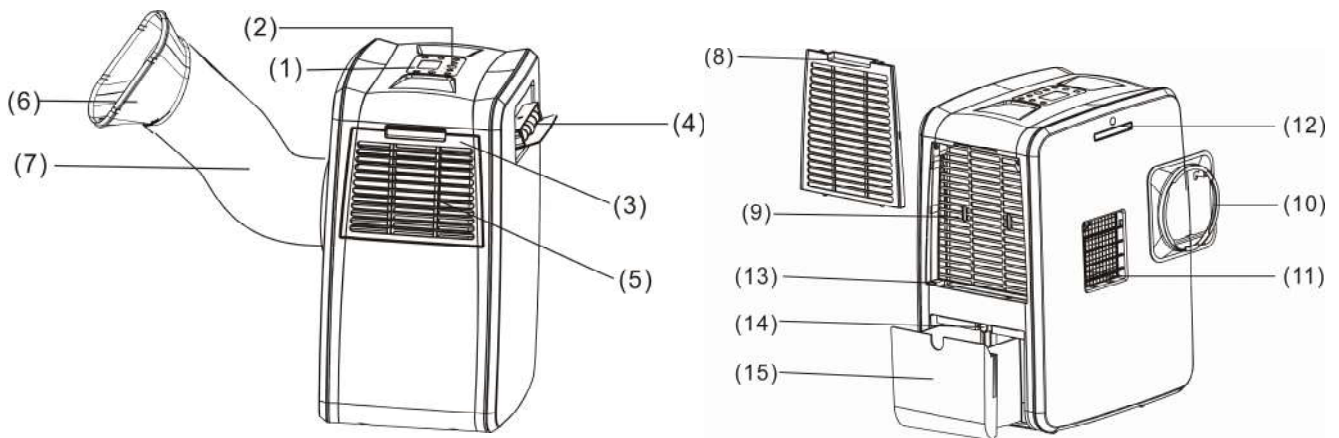

- | | |
|---|---|
| 1. Control panel | 9. Hot air inlet (mount clip (10) storage) |
| 2. Remote control sensor | 10. Hot air outlet hose mount adapter |
| 3. Washable mesh filter (HEPA filter* holder) | 11. Hot air outlet with directional louvres |
| 4. Cold air outlet with swinging louvres | 12. Remote control slide in slot |
| 5. Cold air inlet | 13. Water filling port (humidifier function) |
| 6. Fishtail connector | 14. Water drain port / Rubber water stopper |
| 7. Hot air exhaust hose | 15. Dehumidifier water tank |
| 8. Washable mesh filter (HEPA filter* holder) | * HEPA filters are optional |

INSTALLATION

Warning: Before using this unit, please keep it upright for at least 3-4 hours.

This unit can easily be moved from one room to another.

While moving the unit please note that it must always be kept upright and then placed on an even surface.

Unpacking

Open the box and remove all the packing out of way.

Grip the unit by the carry handles located on either sides of the unit and carefully lift until it slides out of the foam base.

Open the water tank (15) and remove the exhaust hose (7) as in picture.

Remove the side mount clip (10) from hot air inlet (9)

Install the exhaust hose (7) if operating the unit in vented air conditioning mode or spot drying mode

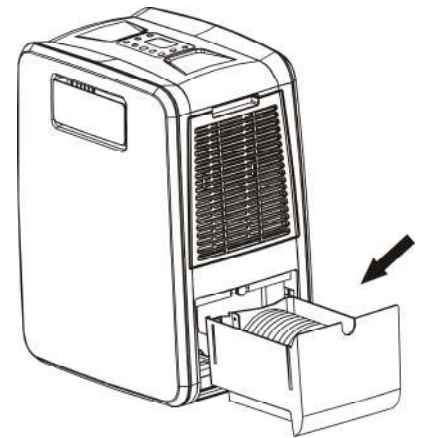

PACKAGE CONTENTS

- 1 / Air Treatment unit
- 2 / Remote control
- 3 / Side mount clip (10)
- 4 / Hose, fish tail (inside the water tank) and window kit
- 5 / HEPA filters (available to be purchased separately)

Assemble the hose (for vented air conditioning mode and directional drying)

1. Remove the hot air exhaust hose (7) from the water tank (15). The fishtail (6) parts (a) and (b) are stored within the hose (7). Prepare both parts (a) and (b) of hose adaptor and clip them together. Do not push too hard as this may cause damage.
2. Open filter (8) and remove hot air exhaust mount adapter (10) from its storage. Clip the hot air exhaust mount (10) over hot air outlet (11) making sure it clicks into place.

The procedure is illustrated bellow.

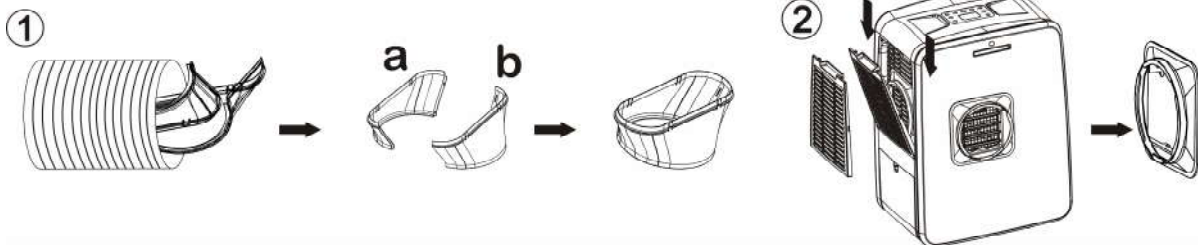

1. Insert the hose (7) in to the fishtail (6) and rotate it at least 3 times until in place
2. Make sure hot air exhaust mount adapter (10) is clipped to the unit
3. Insert the assembled hose and fishtail
4. Rotate is firmly into adapter. To screw it into place should take no less than three rotations.

The procedure is illustrated bellow.

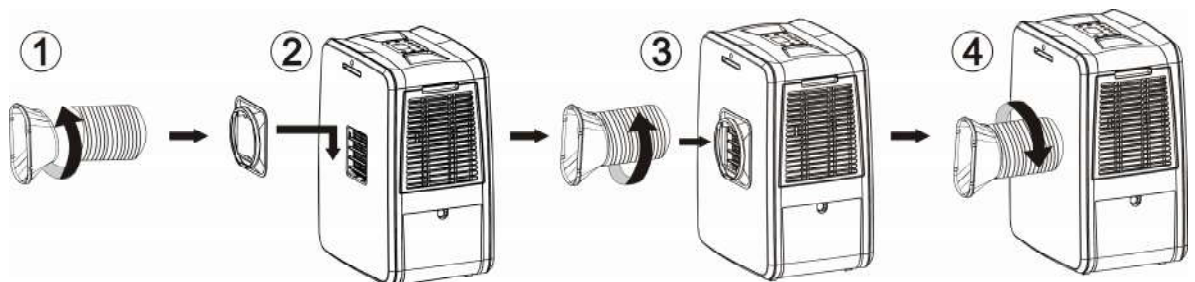

Note: To remove the hose and adapter reverse the procedure

Installation of window kit

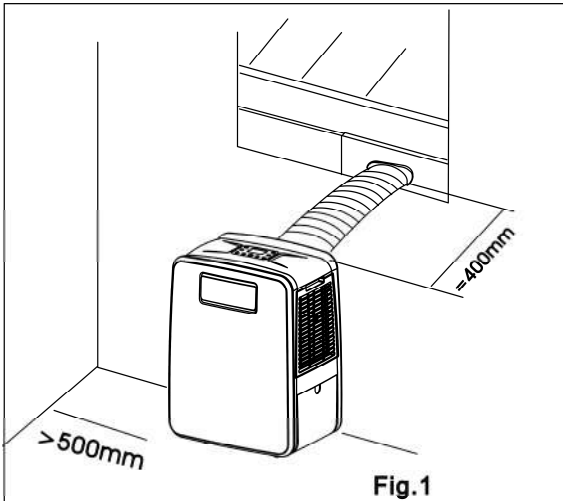

If you want to use the unit more than a spot cooler we recommend to vent it out using the supplied window kit. Partially open the window and then fix the window kit to the window either horizontally (fig.1) or vertically. Clip the other end of the hose with the fishtail adapter to the air outlet of the window slider.

Make sure the unit is upright and there are no obstructions to the air inlets and outlet grills.

Note: The window kit is only designed to be installed with sliding or sash windows or doors. The window kit is not made to be used with any other style of windows. However the fish tail adaptor can be used with most windows / doors but there will be cold air escape making the unit less efficient. When using the cooling mode ensure that the opening left is as small as possible. The best form of installation is through a wall duct.

In order to achieve a drop of temperature in the room, note that the unit will need to be vented out, ideally through the wall. By properly venting your air conditioner expels heat out of your room while efficiently cooling it.

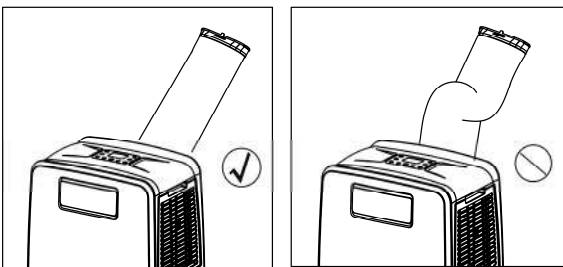

Important safeguards

The length of the soft hose extends from 28 cm to 150 cm. If hose is extended above this length the unit may malfunction and this can invalidate the warranty. The shorter the hose the better the results, 40 cm is the ideal hose length for your AirCube. We recommend the outlet vent must be well ventilated and not obstructed as this will cause the unit to overheat. Avoid bending the air hose more than 30 degrees.

If the unit does not reach the venting point it may be installed on a flat stable surface such as a table or platform. Castors may be removed and rubber mat installed underneath.

OPERATION AND SETTINGS

This portable air conditioner boasts four functions: cooling (spot cooling or vented), dehumidifying, humidifying, air cleaning (with optional HEPA filters) / fan and humidifying.

The fan has three speeds: high, medium and low

Temperature range settings are: 17-30°C

The unit will also display operating function, temperature, humidity, fault diagnostic and protective functions on the LCD screen.

Control panel

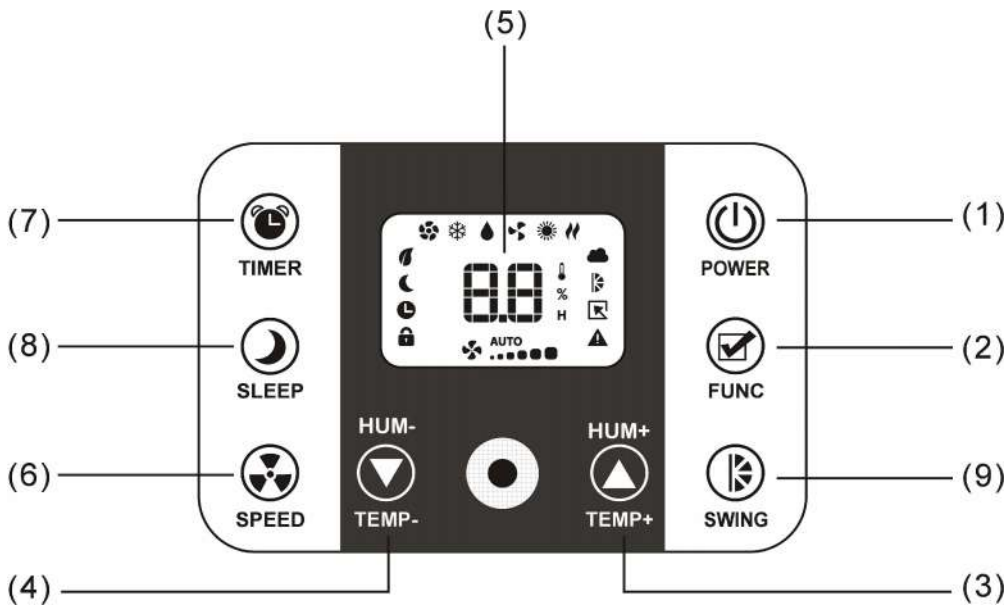



- (1) Power ON / OFF
- (2) Function selection
- (3) Humidity / Temp +
- (4) Humidity / Temp -
- (5) LCD Display
- (6) Fan Speed
- (7) 24 hrs timer
- (8) Sleep mode
- (9) Swing function

	Air Purifier mode		Temperature / Humidity / Hours
	Sleep mode on		Temperature
	Timer on		Humidity
	Humidifier mode		Time
	Swinging on		Fan speed icon
	Error Alarm		Auto mode
	Air Conditioner mode		Fan speed
	Dehumidifier mode		Child Lock

OPERATION GUIDE

When plugged in the unit is automatically in standby status

 **POWER KEY** Press this button to turn the unit on and enter cooling mode.
Press again and the unit will switch off.

 **FUNCTION** Press this key to choose **Air Conditioner, Dehumidifier, Humidifier or Air Purifier Mode** (with optional HEPA filters).

 **TEMP-** and **TEMP+** button: sets temperature in air conditioning mode.
Temperature can range from 17- 30°C. Those keys increase or decrease the preset temperature by 1°C each time they are pressed within the 17- 30°C range.

 **HUM-** and **HUM+** during dehumidifying & humidifying function: This key increases or decreases the preset humidity by 5% each time it is pressed within 30-90% range.

LCD DISPLAY

The display indicates the current setting temperature, humidity or the timer settings and will be accompanied by temperature (°C), humidity (%) or hours (H) signs.

When the set temperature or the timer is adjusted, the new setting is shown then the display returns the current set temperature.

The display will also show function modes and fan speed informations.

※ The display is also used to show error codes should a fault occur, see ERROR CODES.

 **FAN SPEED** HIGH→MEDIUM→LOW and AUTO
If "AUTO" is selected during cooling function the fan speed will **automatically** be adjusted to HIGH, MEDIUM or LOW according to the difference between settings and ambient temperature.

TIMER

Press the icon to select your desired operation time periods.

Use the **TIMER** button to turn on / off the unit after the set time is over.

You can only set the auto-shut off timer while the unit is operating (on)

You can only set the auto-start timer while the unit is in standby (off)

You can set the function and fan speed while setting the timer.

Pressing the **POWER** key before count down turns the unit on or off will clear the settings

AIR CONDITIONER MODE

Select the **air conditioner** mode from function button.

Use  **TEMP-** and **TEMP+** keys to set temperature in air conditioning mode. Those keys increase or decrease the preset temperature by 1°C each time they are pressed within the 17- 30°C range. The AirCube is a fully climate control Air Conditioner. If temperature in the room is higher than set temperature the micro-computer will start the compressor, cooling down.

Also AUTO function can be set for easy operation.

You can use the air cube as personal / spot air cooler with cold air blowing through the

swinging louvres and hot air coming through the back. Please note that in this mode the temperature in the room will not be reduced. You may use the air conditioner in an open vented fireplace as heat will raise from the back of the unit while cooling through the front. We recommend venting the air conditioner with the vent kit supplier through the wall or through the window and using it in a room of appropriate size.

Note: When in air conditioning mode please make sure the rubber water stopper **(14)** is in place to ensure maximum cooling and efficiency. Your AirCube is an advanced self-evaporative air conditioner, which reduces the need to empty the water tank in cooling mode. If the unit is vented correctly most of the water is reused to cool the condenser coils and any excess is evaporated. Please do not use continuous drainage if you intend to use the self-evaporating facility for improved cooling effect.

DEHUMIDIFIER MODE

Select the **dehumidifier** mode from function button. The AirCube dehumidifier contains an intelligent micro-computer that will ensure humidity is measured exactly and is able to maintain a constant humidity dehumidifying with minimum energy expense.

When ambient humidity is lower than set humidity by 2%, compressor will stop automatically for 3.5 minutes saving energy. The micro-computer will measure the humidity and restart the compressor only when the ambient humidity is higher than set humidity by 2%.

HUMIDITY SETTINGS (HUM-, HUM+)

CO(continuous)→30%→35%→40%→45%→50%→55%→60%→65%→70%→75%→80%→85%→90%→**CO**



Laundry mode: Set the humidistat to continuous mode or set the range from 30%-50% and fan speed to maximum and place within 1.5 meters of clothes / laundry dryer. Do not place clothes directly over any of the AirCube's vents. You can also install the hot air exhaust hose and direct it to the spot you want to rapidly dry (e.g. plaster, clothes, shoes, etc.). Make sure that there is nothing blocking the hot air exhaust air flow.

On tank full the dehumidifier will stop operating. Do not remove the water tank before it is full and the dehumidifier stops operating. Once the tank is full wait for another 30 minutes before removing it as water may still defrost into the tank. Do not move the unit once the tank is displaced and ensure rubber stopper in place to prevent water leaks. To resume operation insert the tank back and press power button.

Note: When in dehumidifier mode remove the rubber water stopper **(14)** from drain. Water will go in to the water tank **(15)**. Permanent drainage and water pump can be attached to the unit for unattended use. Occasionally the **DF** may appear on the LCD. The dehumidifier is in defrost mode and normal operation will resume as soon as the defrost cycle finishes. The lower the room temperature the more defrosting will happen.

HUMIDIFIER MODE

Select the **humidifier** mode from function button. The AirCube is a powerful 5 litres per day humidifier.

If your room is too dry or suffering from allergies, your AirCube will help maintaining the exact humidity level you need.

The AirCube intelligent micro-computer will measure the exact humidity in the room and only add enough moisture to achieve the set humidity.

Initially add approximately a litre of water via water filling port **(13)** behind the filter. Set the humidity from HUM- / HUM+ keys.

Unit will stop after about 4 hours. You will need to add more water if necessary (approx. 0.8 litres). Any excess water will go in the main water tank **(15)**.

Fan and the water spray motor will work but the compressor will be turned off in this mode.

Note: When in humidifier mode make sure the rubber water stopper **(14)** is in place otherwise unit will not humidify.

HUMIDITY SETTINGS (HUM-, HUM+)

CO(continuous)→30%→35%→40%→45%→50%→55%→60%→65%→70%→75%→80%→85%→90%→**CO**

AIR PURIFIER / FAN MODE

Select the **Air Purifier** mode from function button. Your AirCube is a dual HEPA air purifier and will improve the indoor air quality.

During normal air cleaning operation the LCD will show  symbol and only the fan motor operates. If used without the optional HEPA filters the unit will operate in fan mode only.

After 2000 hours of fan operation, the Alarm indicator will flash displaying **E8** error. Please change HEPA filters if necessary than press and hold **SPEED** button for 3 seconds to reset the filter change counter.

Note: For improved air flow and performance we recommend to remove the HEPA filters in **Air Conditioner** and **Dehumidifier mode**. Vacuum clean every week the HEPA filters and wash the mesh filters every 2-3 weeks to improve their life.

SLEEP MODE

Select **SLEEP** button to activate



While in **cooling** mode, press the **SLEEP** to enter **SLEEP** mode. It will increase the setting by 1°C after an hour and readjust to a 2°C increase after 2 hours.

SWING

Press this key and the outlet will start oscillating, and it will stop when this key is pressed again. The outlet will close up automatically when the unit stops working.







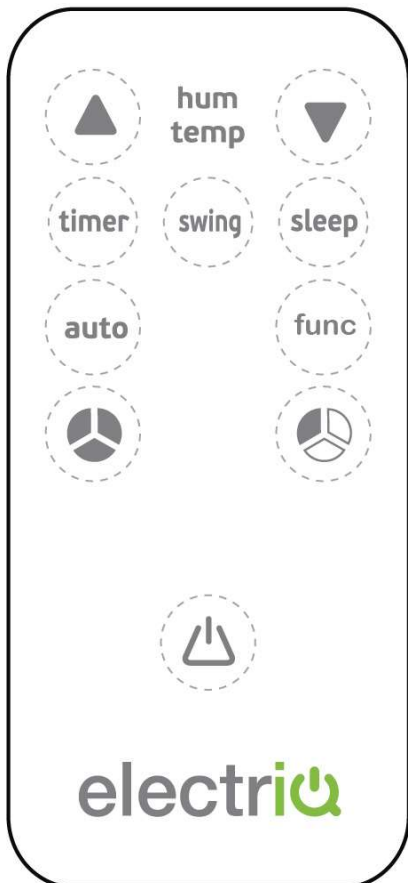

ALARM When the water tank is full, E4 will be displayed on the LED panel. To resume operation, please empty the tank if in **Dehumidifier** mode, or remove the rubber cap from drain hose, wait for internal tank to empty than empty the main tank if in **Air Conditioner** mode. The E4 warning will disappear after draining, and the unit can be restarted by pressing the **Power On** key. **E8** error / air filter change indicator can be reset by pressing the **FAN SPEED** key on the control panel for 3 seconds.

 **CHILD LOCK**

Press   keys on the AirCube control panel at the same time for three seconds and the unit will enter child lock mode; control panel and functions cannot be operated until **CHILD LOCK** is disabled. To resume normal operation please press again the same keys for 3 seconds.

Remote control



-  On/Off
-  Function selection
-  Start/Stop timer
-  Auto operation
-  High fan speed
-  Low fan speed
-  Sleep mode
-  Temp/Humidity + / -
-  Swing mode

Multi protective function

1.1 Anti-freezing protecting control:

When the ambient temperature is low while in Air Conditioner or Dehumidifier mode, the compressor and water pump will stop working if the copper coil temperature is too low. When the copper coil temperature increases, the operation will resume.

1.2、 Water-full protection:

When the water level in the internal / or external water tank is surpassing the maximum level, the unit will alert automatically and E4 will be displayed on the LED screen. Please discharge water in the machine according to “Water Drainage” section.

1.3 Compressor protection

Compressor has an overheating protection function and may stop to prevent compressor damage. Also the compressor runs under a 3 minute delay protection function.

WATER-DRAINAGE

Your AirCube is an advanced self-evaporative air conditioner, which reduces the need to empty the water tank in cooling mode. If the unit is vented correctly most of the water is reused to cool the condenser coils and any excess is evaporated.

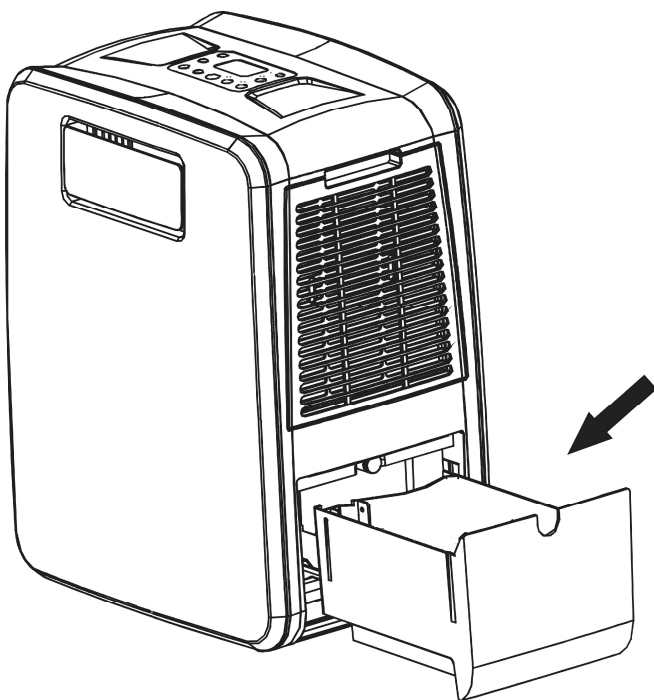

Ensure the rubber water stopper is in place and do not use continuous drainage if you intend to use the self-evaporating facility for improved cooling effect.

Manual drainage:

- 1.1 When either the internal or the external water tank is full the unit will stop working.
- 1.2 Shut off the unit and unplug. Remove the rubber water stopper and leave the internal tank to drain in the external tank for at least 30 minute. Try not to move the model abruptly as this may cause water to spill out from internal water tank.
- 1.3 Empty the external tank
- 1.4 Put the rubber water stopper back (or not if using next in dehumidifier mode).

Continuous drainage:

- 1.1 Remove the rubber water stopper (do not remove the water tank).
- 1.2 Use a water pipe to connect to the water outlet.
- 1.3 You can plumb this pipe into your current plumbing system, lead it outside or use it in a conjunction with a water pump (e.g. cellar use).
- 1.4 This mode is recommended for dehumidifier mode continuous unattended operation.

Notes: When the unit is in the air conditioner mode, it is recommended not to have the water drain pipe installed. Please make sure that the rubber water stopper is in place when the unit is running.

Please remove the air exhaust hose, connect a drain hose to the drain hole and lead the water to the outside in order to intensify dehumidifying capacity.

※ When the water tanks are full, "E4" will be displayed on the display panel. Please remove the rubber water stopper of the drain port to drain out the internal tank first than the external one. After the tanks are empty, please restart the unit and then the unit can operate normally.

Maintenance

Cleaning

Please shut off the unit and unplug from the mains before cleaning or performing any maintenance

Clean the surface

Clean the plastic housing with a duster or a soft wet cloth.

Do not use chemical solvents (such as benzene, alcohol or gasoline) as they may cause irreversible damage.

Air filter cleaning

- a) Clean the air filters at least every 2 weeks. If the air filters are blocked with dust, the unit's performance will be significantly affected.
- b) Pull out both side mesh filters and gently wash them by immersing them in warm (about 40°C) water with a neutral detergent.
- c) Rinse it and then dry it thoroughly
- d) Vacuum clean gently the optional HEPA filters. Never wash them.
- e) Carefully re-install air filters

End of Season Maintenance:

1. Disconnect from main power.
2. Pull out the plug from the drainage hole and empty the internal tank. You can also drain the water by leaning the unit toward the water tank.
3. Empty the external tank
4. Then plug back and switch the unit to low fan mode in air cleaning mode.
5. Keep the unit in this mode for half day - until the conduit is dried. Doing this helps to keep the inside of the unit dry and prevents mold developing
6. Clean the filters as per filter cleaning procedure
7. Turn off the unit and pull out the plug.
8. Separate the air-exhausted pipe, fishtail and exhaust mount and store them safely as you received them.
9. Cover the unit and keep it in a dry place.
10. Take the batteries out of remote control and store, or dispose, them safely

Troubleshooting

Do not repair or disassemble the unit by yourself, unauthorized repair attempts will invalidate the warranty and may cause bodily harm.

Trouble	Reason	Solution
The unit does not work	No power supply	Power-on and turn on the unit.
	Water-full indicator (E4)	Drain the internal / external water tanks
	Filter change counter indicator (E8)	Change filters and / or reset the counter by pressing fan speed key for 3 seconds
	Timer function is active	Cancel Timer function (press power on)
	Room temperature too low or too high	Use only in ambient temperatures between 7-35°C
The unit does not seem to perform.	In direct sunlight	Draw the curtains, also UV affects RC
	Windows or doors open. Large amount of people or a heat source in the room.	Close windows and turn on another air conditioner
	Filter is very dirty	Clean or change the air filter
	Air inlet or air outlet is blocked	Clear out debris
	Room temperature is lower than setting temperature	Change the setting temperature
The unit loud	The unit is not put on flat surface	Put the unit on flat and hard surface
Compressor does not work	Overheating protection is active	Check venting. Restart the unit after 5 minutes when compressor has cooled
Remote control doesn't work	Operating distance is too far.	Move remote control closer to the unit and make sure it aims at temperature sensor
	Control panel has not received the signal from remote control.	
	The batteries is flat	Replace the battery
E1 on LED	Electrical short on both temperature sensor and PCB	Refer to Service Centre
E2 on LED	Electrical short on temperature sensor copper tube and PCB wiring	Refer to Service Centre
E4 on LED	Indicates water tank full or poor contact of signal plug.	If bottom tank was drained and unit restarted refer to Service Centre (Check that the signal plug has been wired correctly.)
DF on LED	Anti-freezing protection	Waiting for defrosting. Function will recover automatically. No user input needed.

If the above solutions do not resolve the problem please contact the service centre.

APPENDIX



Disposal: Do not dispose this product as unsorted municipal waste. Collection of such waste must be handled separately as special treatment is necessary.

Recycling facilities are now available for all customers at which you can deposit your old electrical products. Customers will be able to take any old electrical equipment to participating civic amenity sites run by their local councils. Please remember that this equipment will be further handled during the recycling process, so please be considerate when depositing your equipment. Please contact the local council for details of your local household waste recycling centres.

TECHNICAL DATA

MODEL	AIRCUBE®	AIRCUBE® MAX
Cooling Capacity	0.9 kW	1.1 kW
Moisture Removal	25l/day (at 30°C/ 80%RH)	30l/day (at 30°C/ 80%RH)
Humidifying Capacity	0.2 litres/ hour	0.2 litres/ hour
Rated Input (EN 60335)	Cooling: 360 W	Cooling: 610 W
Rated Dehumidifier power	360 W	610 W
Rated Humidifier power	60 W	60 W
Running Current	Cooling: 1.6 A	Cooling: 2.8 A
Max Noise Level (Sound Pressure)	56 dB(A)	56 dB(A)
Noise Level (Sound Energy)	46 dB(A)	46 dB(A)
Air Flow	150m ³ /hr	150 m ³ /hr
Maximum Allowable Pressure	5.5 Mpa	2.5 Mpa
Power Supply	220-240V/50Hz	220-240V/50Hz
Fuse	250VAC 2A	250VAC 2A
REFRIGERANT	R410A, 185 g	R134A, 210 g
Net Weight	15.5 kgs	17.4 kgs
Dimension(mm)	285Wx 375Dx 500H	285Wx 375Dx 500H
Water tank capacity	2.6 litres	2.6 litres

(CE) N 842/2006: R410A/R134a is a type fluorinated greenhouse gases covered by the Kyoto Protocol. R410A's total global warming potential (GWP) is 1975, and R134a's total global warming potential (GWP) is 1300.

ElectriQ UK SUPPORT
www.ElectriQ.co.uk/support

Please, for your own convenience, read the troubleshooting guide before calling the service line.

If the unit still fails to operate call: 0871 620 1057 or complete the online form

Also check:

- 1. Has the unit been standing upright for at least 2 hours?**
- 2. Is the unit plugged into the mains?**
- 3. Is the fuse OK?**
- 4. Switch the unit off and wait three minutes to see if the issue is resolved. Restart the unit.**
- 5. Check if the water tank is full.**

Office hours: 9AM - 5PM Monday to Friday

**www.ElectriQ.co.uk
Unit 2, The Nursery
Berristow Lane
South Normanton
Derbyshire, DE55 2FX**