

# FUJITSU Server PRIMERGY TX2550 M4

## Operating Manual

## **Comments... Suggestions... Corrections...**

The User Documentation Department would like to know your opinion of this manual. Your feedback helps us optimize our documentation to suit your individual needs.

Feel free to send us your comments by e-mail to [manuals@ts.fujitsu.com](mailto:manuals@ts.fujitsu.com).

## **Certified documentation according to DIN EN ISO 9001:2008**

To ensure a consistently high quality standard and user-friendliness, this documentation was created to meet the regulations of a quality management system which complies with the requirements of the standard DIN EN ISO 9001:2008.

cognitas. Gesellschaft für Technik-Dokumentation mbH  
[www.cognitas.de](http://www.cognitas.de)

## **Copyright and Trademarks**

Copyright 2017 FUJITSU LIMITED

All rights reserved.

Delivery subject to availability; right of technical modifications reserved.

All hardware and software names used are trademarks of their respective manufacturers.

- The contents of this manual may be revised without prior notice.
- Fujitsu assumes no liability for damages to third party copyrights or other rights arising from the use of any information in this manual.
- No part of this manual may be reproduced in any without the prior written permission of Fujitsu.

Microsoft, Windows, Windows Server, and Hyper-V are trademarks or registered trademarks of Microsoft Corporation in the USA and other countries.

Intel and Xeon are trademarks or registered trademarks of Intel Corporation or its subsidiaries in the USA and other countries.

---

## Before reading this manual

### For your safety

This manual contains important information for safely and correctly using this product.

Carefully read the manual before using this product. Pay particular attention to the accompanying manual "Safety Notes and Regulations" and ensure these safety notes are understood before using the product. Keep this manual and the manual "Safety Notes and Regulations" in a safe place for easy reference while using this product.

### Radio interference

This product is a "Class A" ITE (Information Technology Equipment). In a domestic environment this product may cause radio interference, in which case the user may be required to take appropriate measures. VCCI-A

### Aluminum electrolytic capacitors

The aluminum electrolytic capacitors used in the product's printed circuit board assemblies and in the mouse and keyboard are limited-life components. Use of these components beyond their operating life may result in electrolyte leakage or depletion, potentially causing emission of foul odor or smoke.

As a guideline, in a normal office environment (25°C) operating life is not expected to be reached within the maintenance support period (5 years). However, operating life may be reached more quickly if, for example, the product is used in a hot environment. The customer shall bear the cost of replacing replaceable components which have exceeded their operating life. Note that these are only guidelines, and do not constitute a guarantee of trouble-free operation during the maintenance support period.

### High safety use

This product has been designed and manufactured to be used in commercial and/or industrial areas as a server.

When used as visual display workplace, it must not be placed in the direct field of view to avoid incommoding reflections (applies only to TX server systems).

The device has not been designed or manufactured for uses which demand an extremely high level of safety and carry a direct and serious risk of life or body if such safety cannot be assured.

---

These uses include control of nuclear reactions in nuclear power plants, automatic airplane flight control, air traffic control, traffic control in mass transport systems, medical devices for life support, and missile guidance control in weapons systems (hereafter, "high safety use"). Customers should not use this product for high safety use unless measures are in place for ensuring the level of safety demanded of such use. Please consult the sales staff of Fujitsu if intending to use this product for high safety use.

### **Measures against momentary voltage drop**

This product may be affected by a momentary voltage drop in the power supply caused by lightning. To prevent a momentary voltage drop, use of an AC uninterruptible power supply is recommended.

(This notice follows the guidelines of Voltage Dip Immunity of Personal Computer issued by JEITA, the Japan Electronics and Information Technology Industries Association.)

### **Technology controlled by the Foreign Exchange and Foreign Trade Control Law of Japan**

Documents produced by Fujitsu may contain technology controlled by the Foreign Exchange and Foreign Trade Control Law of Japan. Documents which contain such technology should not be exported from Japan or transferred to non-residents of Japan without first obtaining authorization in accordance with the above law.

### **Harmonic Current Standards**

This product conforms to harmonic current standard JIS C 61000-3-2.

### **Only for Japan: About SATA HDDs**

The SATA version of this server supports HDDs with SATA / BC-SATA storage interfaces. Please note that the usage and operation conditions differ depending on the type of HDD used.

Please refer to the following internet address for further information on the usage and operation conditions of each available type of HDD:

<http://jp.fujitsu.com/platform/server/primergy/harddisk/>

---

# Content

<b>1</b>	<b>Introduction . . . . .</b>	<b>9</b>
<b>1.1</b>	<b>Concept and target groups for this manual . . . . .</b>	<b>9</b>
<b>1.2</b>	<b>Documentation overview . . . . .</b>	<b>10</b>
<b>1.3</b>	<b>Notational conventions . . . . .</b>	<b>11</b>
<b>2</b>	<b>Functional overview . . . . .</b>	<b>13</b>
<b>2.1</b>	<b>Features . . . . .</b>	<b>13</b>
<b>2.2</b>	<b>Server specification . . . . .</b>	<b>23</b>
<b>3</b>	<b>Installation steps, overview . . . . .</b>	<b>31</b>
<b>4</b>	<b>Important information . . . . .</b>	<b>33</b>
<b>4.1</b>	<b>Safety instructions . . . . .</b>	<b>33</b>
<b>4.2</b>	<b>CE conformity . . . . .</b>	<b>42</b>
<b>4.3</b>	<b>FCC Class A Compliance Statement . . . . .</b>	<b>43</b>
<b>4.4</b>	<b>Environmental protection . . . . .</b>	<b>44</b>
<b>5</b>	<b>Hardware installation . . . . .</b>	<b>47</b>
<b>5.1</b>	<b>Unpacking the server . . . . .</b>	<b>48</b>
<b>5.2</b>	<b>Setting up the floorstand model . . . . .</b>	<b>49</b>
<b>5.3</b>	<b>Installing/removing the server in/from the rack . . . . .</b>	<b>50</b>
<b>5.4</b>	<b>Connecting devices to the server . . . . .</b>	<b>52</b>
<b>5.5</b>	<b>Connecting the server to the mains . . . . .</b>	<b>57</b>
<b>5.5.1</b>	<b>Using the cable clamp . . . . .</b>	<b>58</b>
<b>5.6</b>	<b>Notes on connecting/disconnecting cables . . . . .</b>	<b>59</b>

## Content

---

<b>6</b>	<b>Starting up and operation</b>	<b>61</b>
<b>6.1</b>	<b>Access to the drives (floorstand model)</b>	<b>61</b>
6.1.1	Enabling access to the accessible drives	61
6.1.2	Access to the HDD modules (floorstand model)	62
<b>6.2</b>	<b>Controls and indicators</b>	<b>63</b>
6.2.1	Server front	63
6.2.1.1	Controls on the front panel	63
6.2.1.2	Indicators on the front panel	65
6.2.1.3	Indicator on the ODD	68
6.2.1.4	Indicators on the hot-plug HDD/SSD module	69
6.2.2	Server rear	70
6.2.2.1	Indicators on the I/O panel	70
6.2.2.2	Indicators on PSUs (slide-in units)	74
<b>6.3</b>	<b>ID card</b>	<b>75</b>
<b>6.4</b>	<b>Switching the server on and off</b>	<b>76</b>
<b>6.5</b>	<b>Configuring the server</b>	<b>79</b>
6.5.1	Configuring the onboard SATA controller	79
6.5.2	Configuring the SAS/SATA RAID controller (PCIe expansion card)	80
6.5.3	Configuring the server and installing the operating system with the ServerView Installation Manager	81
6.5.4	Configuring the server and installing the operating system without the ServerView Installation Manager	82
<b>6.6</b>	<b>Cleaning the server</b>	<b>83</b>
<b>7</b>	<b>Property and data protection</b>	<b>85</b>
<b>7.1</b>	<b>BIOS setup security functions</b>	<b>85</b>
<b>8</b>	<b>Troubleshooting and tips</b>	<b>87</b>
<b>8.1</b>	<b>Power-on indicator remains unlit</b>	<b>87</b>
<b>8.2</b>	<b>Server switches itself off</b>	<b>88</b>
<b>8.3</b>	<b>Screen remains blank</b>	<b>88</b>
<b>8.4</b>	<b>Flickering stripes on monitor screen</b>	<b>89</b>

<b>8.5</b>	<b>No screen display or display drifts . . . . .</b>	<b>89</b>
<b>8.6</b>	<b>No mouse pointer displayed on screen . . . . .</b>	<b>89</b>
<b>8.7</b>	<b>System will not boot . . . . .</b>	<b>90</b>
<b>8.8</b>	<b>Incorrect date and time . . . . .</b>	<b>90</b>
<b>8.9</b>	<b>Hard disk drive error messages at system boot . . . . .</b>	<b>91</b>
<b>8.10</b>	<b>Added drive reported as defective . . . . .</b>	<b>92</b>
<b>8.11</b>	<b>Error message on screen . . . . .</b>	<b>92</b>
<b>8.12</b>	<b>Expansion cards or onboard devices not recognized . . . . .</b>	<b>92</b>
<b>8.13</b>	<b>Temperature warning . . . . .</b>	<b>93</b>
<b>8.14</b>	<b>No effect of keyboard or mouse . . . . .</b>	<b>93</b>
<b>8.15</b>	<b>Optical drive cannot read data . . . . .</b>	<b>93</b>

# Content

---



---

# 1 Introduction

## **PRIMERGY TX2550 M4 floorstand model**

The PRIMERGY TX2550 M4 is a no compromise tower server with maximum levels of performance, expandability and availability.

The new modular concept supports excellent expandability with up to 32 2.5-inch HDDs or up to 12 3.5-inch HDDs, up to 10 PCIe Gen 3 cards and up to 1536 GB memory. Moreover the 2 hot-plug PSUs with up to 94% efficiency and the new power management, will result in lower operational costs. Thanks to the upgrade kits as well as the cost-saving LAN options, the TX2550 M4 is prepared for future requirements. TX2550 M4 is ideal for database, consolidation or high performance computing scenarios.

## **PRIMERGY TX2550 M4 rack model**

The PRIMERGY TX2550 M4 rack model is a 4U rack server with maximum levels of performance, expandability and availability.

The new modular concept supports excellent expandability with up to 32 2.5-inch HDDs or up to 12 3.5-inch HDDs, up to 10 PCIe Gen 3 cards and up to 1536 GB memory. Moreover the 2 hot-plug PSUs with up to 94% efficiency and the new power management, will result in lower operational costs. Thanks to the upgrade kits as well as the cost-saving LAN options, the TX2550 M4 is prepared for future requirements. TX2550 M4 is ideal for database, consolidation or high performance computing scenarios.

The floorstand model can be converted to a rack model using an optional conversion kit.

## 1.1 Concept and target groups for this manual

This operating manual describes how to install, set up and operate your server.

This operating manual is intended for those responsible for installing the hardware and ensuring that the system runs smoothly. It contains all the information you need to put your PRIMERGY TX2550 M4 into operation.

To understand the various expansion options, you will need to be familiar with the fields of hardware and data transmission and you will require a basic knowledge of the underlying operating system.

### 1.2 Documentation overview

More information on your PRIMERGY TX2550 M4 can be found in the following documents:

- "Quick Start Hardware - FUJITSU Server TX2550 M4" leaflet
- ServerView Quick Start Guide
- "Safety Notes and Regulations" manual  
"安全上のご注意" for Japan
- "Warranty" manual  
"保証書" for Japan
- "ServerView Suite Local Service Concept - LSC" manual
- "Returning used devices" manual and "Service Desk" leaflet  
"サポート&サービス" for Japan
- "FUJITSU Server PRIMERGY TX2550 M4 Server Upgrade and Maintenance Manual"
- "D3386 BIOS Setup Utility for FUJITSU Server PRIMERGY TX2550 M4 Reference Manual"
- "iRMC S5 - Concepts and Interfaces" user guide
- "iRMC S5 - Configuration and Maintenance" user guide
- "iRMC S5 - Web Interface" user guide
- "ServerView embedded Lifecycle Management (eLCM)" User Guide
- "Integrated RAID for SAS User Guide"
- "LSI MegaRAID - SAS Software User Guide"
- "Modular RAID Controller / Modular SAS HBA Installation Guide"



All documentation on PRIMERGY hardware and ServerView software is available online from the Fujitsu manuals server at:

<http://manuals.ts.fujitsu.com>

For Japan:

<http://www.fujitsu.com/jp/products/computing/servers/primergy/manual/>

The complete PRIMERGY documentation set can also be downloaded as a DVD ISO image at:

<ftp://ftp.ts.fujitsu.com/images/serverview/manuals>

For Japan:



<http://www.fujitsu.com/jp/products/computing/servers/primergy/downloads/>

#### Further sources of information:

- ServerView Suite Glossary
- Manual for the monitor
- Documentation for the boards and drives
- Operating system documentation
- Information files in your operating system

## 1.3 Notational conventions

The following notational conventions are used in this manual:

<i>Text in italics</i>	indicates commands or menu items.
"Quotation marks"	indicate names of chapters and terms that are being emphasized.
▶	describes activities that must be performed in the order shown.
 <b>CAUTION!</b>	pay particular attention to texts marked with this symbol. Failure to observe this warning may endanger your life, destroy the system or lead to the loss of data.
	indicates additional information, notes and tips.



---

## 2 Functional overview

This section provides information on the features and technical data of the PRIMERGY TX2550 M4 server. For information on key characteristics and layout of the system board, see the "FUJITSU Server PRIMERGY TX2550 M4 Server Upgrade and Maintenance Manual".

### 2.1 Features

#### Customer Self Service (CSS)

The PRIMERGY Customer Self Service (CSS) concept enables you to identify and replace the affected component yourself in the case of certain error scenarios.

In the CSS concept, you can replace the following components yourself in the event of an error:

- Hot-plug HDD/SSD modules
- Hot-plug PSUs
- Memory modules
- System fans
- Expansion cards

For information on replacing these components, see the "FUJITSU Server PRIMERGY TX2550 M4 Upgrade and Maintenance Manual".

CSS indicators on the control panel and on the back of the PRIMERGY server provide you with information if a CSS event arises.

In addition, CSS errors are displayed in the ServerView Operations Manager, the server management software from Fujitsu.

In the event of errors, the ServerView Operations Manager refers you directly to the affected component and its order information in the Illustrated Spares catalog of the server in question. (This feature is not available for Japan.)



Further information on the CSS concept is provided in the "PRIMERGY ServerView Suite Local Service Concept - LSC" manual on the Fujitsu manuals server.

For the latest information on optional products provided for the TX2550 M4 see the configurator of the server:

[http://ts.fujitsu.com/products/standard\\_servers/index.html](http://ts.fujitsu.com/products/standard_servers/index.html)

For Japan:

<http://www.fujitsu.com/jp/products/computing/servers/primergy/>

### System board

The features of the system board are described in the "FUJITSU Server PRIMERGY TX2550 M4 Upgrade and Maintenance Manual", the setup possibilities are described in the "D3386 BIOS Setup Utility for FUJITSU Server PRIMERGY TX2550 M4 Reference Manual".

### Trusted Platform Module (TPM)

A Trusted Platform Module (TPM) for safer storage of keys can be implemented as an option. This module enables programs from third party manufacturers to store key information (e.g. drive encryption using Windows Bitlocker Drive Encryption).

The TPM is activated via the BIOS system (for more information, refer to the "D3386 BIOS Setup Utility for FUJITSU Server PRIMERGY TX2550 M4 Reference Manual").



#### **CAUTION!**

- When using the TPM, note the program descriptions provided by the third party manufacturers.
- You must also create a backup of the TPM content. To do this, follow the third party manufacturer's instructions. Without this backup, if the TPM or the system board is faulty you will not be able to access your data.
- If a failure occurs, please inform your service about the TPM activation before it takes any action, and be prepared to provide them with your backup copies of the TPM content.

## Slots for expansion cards

The server can be flexibly expanded via six full height PCIe Gen3 low profile adapters (3 PCIe x8, 3 PCIe x16).

One horizontal chassis slot is occupied by the OCP module.

Further information on the OCP module is provided in the associated documentation.

## HDDs

The server is shipped with one of the following drive cages:

- For up to twelve 3.5-inch SAS/SATA HDDs:

Up to twelve SAS HDD modules can be used in the drive cage. Each HDD module can accommodate a SAS HDD with a maximum height of 1 inch. The module is connected to the SAS backplane wirelessly. This allows HDD/SSD modules to be plugged in and pulled out easily.

Optionally, you can also install a HDD expansion box (Multibay 2, see also section "[Accessible drives / components](#)" on page 17) (with up to four 3.5-inch SAS/SATA HDD modules). The HDD in this expansion box are controlled by a SAS expansion card or by a second 8-Port RAID Controller.

- For up to thirty-two 2.5-inch SAS HDDs/SSDs:

Up to thirty-two SAS HDD/SSD modules can be used in the drive cage. Each HDD/SSD module can accommodate an SAS HDD/SSD with a 2.5-inch format. The module is connected to the SAS backplane wirelessly. This allows HDD/SSD modules to be plugged in or pulled out easily.

Optionally, you can also install a HDD expansion box (with up to eight 2.5-inch SAS HDD/SSD modules). An additional SAS controller must be installed in order to control the HDDs in this expansion box. The HDDs in this expansion box are controlled by a SAS expansion card or by a second 8-Port RAID Controller.



Hybrid configurations of SAS and SATA HDD/SSD modules are not supported.

## Onboard SATA controller

One SATA controller is integrated on the system board; up to four SATA HDDs can be connected to the controller. The LSI Embedded MegaRAID software (Software RAID) supports RAID levels 0, 1 and 10.

For more information on configuring the controller, see section ["Configuring the onboard SATA controller" on page 79](#).

### **SAS/SATA RAID controller (pluggable PCI-e expansion card)**

The server is available with the following SAS/SATA RAID controllers for operating the internal SAS/SATA HDDs:

- Modular RAID 0/1 controller with "MegaRAID functionality" (SAS MegaRAID) for SAS1.0 and SAS2.0

RAID levels 0, 1 and 10 are supported for internal HDD configurations.

- Modular RAID 5/6 controller with "MegaRAID functionality" (SAS MegaRAID) for SAS1.0 and SAS2.0

RAID levels 0, 1, 10, 5, 50, 6 and 60 are supported for internal HDD configurations. As an option, a flash backup unit (FBU) can save the memory content even if the power fails. Cache memory size of 1 Gbyte or 2 Gbyte is available.



For more information on configuring the controller, see section ["Configuring the SAS/SATA RAID controller \(PCIe expansion card\)" on page 80](#).

Further information on SAS/SATA RAID controllers is provided in the "Modular RAID Controller Installation Guide" (on the Fujitsu manuals server under *x86 Servers - Expansion Cards - Storage Adapters - LSI SAS / SCSI RAID Controllers*).

Further information on other SAS/SATA RAID controllers (e.g. for operating external SAS/SATA HDDs or tape drives) is available on the Fujitsu manuals server under *x86 Servers - Expansion Cards - Storage Adapters - LSI SAS / SCSI RAID Controllers*.



### Accessible drives / components

With most configurations the TX2550 M4 offers 3 x 1.6" bay in the accessible drives area located at the top of the tower server (or at the right side of the rack) for various ODD and or backup drives.

### USB connectors

Two USB 3.0 connectors on the front of the device support activities carried out by the service technician. The maximum length of the external cable is two meters for the USB connectors on the front.

Another four USB connectors are available on the rear of the device (4x USB 3.0).

### Power supply unit (PSU)

In its basic configuration, the server has a hot-pluggable PSU that adjusts automatically to any power voltage in the range from 100 V to 240 V (Platinum) or 200 V to 240 V (Titanium). As an option, the power supply can be expanded with an extra PSU to create a redundant power supply. If a PSU fails, the redundant configuration assures continued operation. The defective PSU can be replaced during operation (for further details see the "FUJITSU Server PRIMERGY TX2550 M4 Server Upgrade and Maintenance Manual").

### Advanced Thermal Design

The Advanced Thermal Design option allows you to operate the system with a wider temperature range either of 5 °C to 40 °C or 5 °C to 45 °C, depending on your system and configuration.



This option can only be ordered from the manufacturer and is indicated by the respective logo on the identification rating plate.



### CAUTION

In a system that is configured with Advanced Thermal Design, only certain components which support the respectively increased higher operating temperature range may be installed and used. For applicable restrictions, please refer to the official configurator tool.

### High level of availability and data security

When memory data is accessed, 1-bit errors are identified in the main memory and automatically corrected with the error correcting code (ECC) method. The patented memory scrubbing function regularly starts up the EDC mechanism, ensuring continuous data integrity.

The memory modules used support SDDC technology (Chipkill™), which further increases the effectiveness of memory error monitoring and correction.

Support is likewise provided for hot-spare memory technology, in which a memory bank is used like a replacement bank. If a memory module fails, the bank with the defective memory is automatically deactivated and the replacement bank is activated (provided it has been configured for appropriately in the BIOS). The deactivated memory bank is no longer used and the faulty memory module can be replaced at the next opportunity. In order to be able to use the hot-spare memory function, all occupied memory banks should be equipped with identical memory modules.

Memory modules can be protected against failure by mirroring (Memory Mirroring). Memory Mirroring is roughly comparable to RAID level 1 for HDD arrays. The basic configuration requires two identical memory modules in two different banks.

ASR&R (Automatic Server Reconfiguration and Restart) restarts the system in the event of an error and automatically "hides" the defective system components.

The PDA (Prefailure Detection and Analysis) technology from Fujitsu analyzes and monitors all components that are critical for system reliability.

The SAS/SATA RAID controller supports different RAID levels and increase the availability and data security of the system.

## **iRMC S5 with integrated management LAN connector**

The iRMC S5 (integrated **R**emote **M**anagement **C**ontroller) resides on the system board with integrated management LAN connector and expanded functionality. The iRMC S5 enables complete control of PRIMERGY servers, regardless of system status, and thus particularly the control of PRIMERGY servers that are in the "out-of-band" system status.

Major functions supported by the iRMC S5 include the following:

- Browser access via iRMC S5's own Web server
- Secure communication (SSH, SSL)
- Power Management for the managed server (depending on its system status)
- Power Consumption Management
- Connecting virtual drives as remote storage
- Text-based and graphic console bypass (Advanced Video Redirection)
- Remote Storage
- Command Line Interface (CLI)
- Simple, interactive or script-based iRMC S5 configuration
- Customer Self Service (CSS)
- iRMC S5's own user management
- Multi-computer, global iRMC S5 user administration using an LDAP Directory Service
- Automatic network configuration via DNS / DHCP
- Power supply of the iRMC S5 via the system standby supply
- Full-coverage alarm management
- System Event Log (SEL) reading and processing
- IPMI support
- CIM / WS-MAN support
- Internal Event Log for user login / logout auditing

More information about the iRMC S5 can be found in the "iRMC S5 - integrated Remote Management Controller" user guide (on the Fujitsu manuals server under *x86 Servers - Software - ServerView Suite - Out-Of-Band Management*).

### Server management

Server management is implemented using the ServerView Operations Manager supplied and the PDA (Prefailure Detection and Analysis) technology from Fujitsu. PDA reports the threat of a system error or overload at an early stage, allowing preventive measures to be taken.

The ServerView Operations Manager enables the management of all PRIMERGY servers in the network via a central console. The ServerView Operations Manager supports the following functions:

- Round-the-clock monitoring, regardless of server status
- High-performance, graphical console bypass (AVR) protected by HTTPS/SSL (128 bit)
- Remote storage via USB
- Remote power on
- Intrusion detection in the floorstand model
- Temperature monitoring of the CPU and the surrounding area
- Detailed status and error reports for CPUs and main memory
- Watchdog timer for Automatic Server Reconfiguration and Restart (ASR&R) in the event that memory modules or CPUs fail
- Power monitoring
- End-of-life monitoring of fans with prompt notification before failure
- Watchdog timer for monitoring the operating system with ASR&R

Further information on the ServerView Operations Manager is provided in the associated documentation.

### **ServerView Installation Manager**

You can configure the PRIMERGY server quickly and precisely with the ServerView Installation Manager software provided. User-guided menus are available for installing the server operating system (for further details see section "[Configuring the server](#)" on page 79).

### **Service and support**

PRIMERGY servers are easy to maintain and modular, thus enabling quick and simple maintenance.

The handles and locks (touch points) used to exchange components are colored green to ensure simple and immediate recognition.

In order to prevent the components from being damaged by incorrect handling when they are being installed and removed, the areas of all components that can be touched without damaging them are also marked green.

PRIMERGY diagnostic LEDs fitted on the system board indicate which component (memory module, CPU, fan or expansion card) is not functioning properly.

The Flash EPROM program supplied with the Fujitsu utilities supports a fast BIOS update.

With the iRMC (integrated Remote Management Controller) on the system board, the PRIMERGY TX2550 M4 server can also be maintained and serviced remotely. This enables remote diagnosis for system analysis, remote configuration and remote restart should the operating system or hardware fail.

### ServerView Remote Management

ServerView Remote Management is the remote management solution from Fujitsu for PRIMERGY servers. ServerView Remote Management and the relevant hardware components integrated on the system board allow remote monitoring and maintenance as well as fast restoration of operation in the event of errors.

Remote monitoring and maintenance avoids time-consuming and costly on-site repairs and reduces service costs. This leads to a reduction in the total cost of ownership and an excellent return on investment for the remote management solution.

The administrator can access all system information and information from the sensors such as fan speeds or voltages via the iRMC S5's Web interface (see section ["iRMC S5 with integrated management LAN connector" on page 19](#)). You can also start the text-based or graphic console bypass (Advanced Video Redirection, AVR) and connect virtual drives as remote storage.



More information about the iRMC S5 can be found in the iRMC S5 user guides (on the Fujitsu manuals server under *x86 Servers - Software - ServerView Suite - Out-Of-Band Management*).

## 2.2 Server specification

This section explains the specifications for the server. The specifications for this server are liable to be updated without any notice. Please be forewarned.

### System board

System board type	D3386
Chipset	Intel C624

### Processor (CPU)

CPU quantity and type	Up to 2x Intel® Xeon® CPUs E5-26xx v5 series, max. 135 W, up to 20 cores
-----------------------	--

### Memory modules configuration

Memory slots	12
Memory type	DIMM (DDR4)
Memory capacity (min. - max.)	up to 384 GB (12x RDIMM) up to 768 GB(12x RDIMM 3DS)
Memory protection	Memory Scrubbing; SDDC (only for registered DIMMs); Hot-spare memory support Memory Mirroring support; Rank sparing memory support
Memory notes	Memory Mirroring with identical modules in both channel pairs of a bank (4 modules per bank), Rank sparing or Performance Mode with identical modules in all four channels (4 modules per bank).

## Functional overview

---

### Interfaces

USB	6 x USB 3.0 (2 x front, 4 x rear) Internal: 1x USB2.0 (Backup), 1x USB3.0 (Type A)
Graphics (15-pin)	1 x VGA
Serial 1 (9-pin)	1 x serial RS-232-C, usable for iRMC S5 or system or shared (optional)
LAN / Ethernet	OCP option: <ul style="list-style-type: none"><li>– 2 x 10 GBit/s (RJ45)</li><li>– 2 x 10 GBit/s (SFP+)</li></ul>
Management LAN (RJ45)	1 x dedicated management LAN port for iRMC S5 (10/100/1000 Mbit/s). Management LAN traffic can be switched to shared onboard converged network adapter.

### Onboard or integrated controllers

RAID controller	Two 4 port internal 6G SATA for HDDs with RAID level 0/1/5/10.  For additional RAID controller options are described under <a href="#">"RAID controllers (expansion cards)" on page 25</a>
SATA controller	Intel® C624, 1 x SATA channel for ODD
LAN controller	2x 1Gbit/s LAN connector onboard (RJ45)



Remote Management Controller	Integrated Remote Management Controller (iRMC S5), 256 MB DDR3-800 SRAM for video, IPMI 2.0 compatible
Trusted Platform Module (TPM)	Infineon / separate module; TCG V1.2 or TCG V2.0 compliant (option)

**RAID controllers (expansion cards)**

RAID controllers	<p>RAID 5/6 Ctrl., HDD SAS up to 12 Gbit/s, LSI, 8 ports ext. RAID level: 0, 1, 10, 5, 50, 6, 60, 1 GB Cache, Optional FBU (based on LSI SAS3108).</p> <p>RAID 5/6 Ctrl., HDD SAS up to 12 Gbit/s, 8 ports int. RAID level: 0, 1, 10, 5, 50, 6, 60, 2 GB Cache, Optional FBU (based on LSI SAS3108).</p> <p>RAID 0/1 Ctrl., SAS/SATA 6 Gb, 8 ports int. RAID level: 0, 1, 10, No FBU support.</p>
------------------	---

**Slots**

<b>Standard</b>	
PCI-Express - Gen3 x16	3 x full height
PCI-Express - Gen3 x8	3 x full height
<b>Expansion with riser module</b>	
PCI-Express - Gen3 x8	5 x full height
PCI-Express - Gen3 x16	2 x full height
PCI 32-Bit/33MHz (5V)	1 x full height 270 mm max. length
Slot notes	Integrated RAID Controller occupies 1 x PCI Express (not available when expander is mounted)

## Functional overview

---

### Drive bays

Hard disk bay configuration	Up to 32x hot plug 2.5-inch, or up to 12x hot plug 3.5-inch Up to 8x PCIe SSD
Accessible drive bays	Up to 3x 1.6" drive bays for ODD or backup

### Operating panel

Operating buttons	On/off button
	Reset button
	NMI button
	ID button
Status LEDs	Global error indicator (orange)
	ID indicator (blue)
	HDD activity indicator (green)
	Power-on indicator (green)
	AC connected indicator (green)
	CSS indicator (orange)
Status LEDs at system rear side:	Global error / CSS / ID indicator (orange / orange / blue)
	LAN connection indicator (green)
	LAN speed indicator (green / yellow)

**Dimensions / weight**

Tower (W x D x H)	177 mm x 777 mm x 456 mm
Rack (W x D x H)	482.6 mm (bezel) / 448 mm (body) x 736 mm x 177 mm
Height unit rack	4 U
Mounting depth rack	700 mm
19" rack mount	Yes
Weight	35 kg
Weight notes	Weight may vary depending on actual configuration
Rack mounting kit	Rack mounting kit as option

**Ventilation clearance**

There must be a clearance of at least 200 mm in front of and behind the server to ensure adequate ventilation of the subsystem.

**Ambient conditions**

Environment class 3K2	EN 60721 / IEC 721 Part 3-3
Environment class 2K2	EN 60721 / IEC 721 Part 3-2
Temperature:	
Operation (3K2)	5°C ... 40°C (with Fujitsu ATD 40°) 5°C ... 45°C (with Fujitsu ATD 45°) 10°C ... 35°C (without Fujitsu ATD)
Transport (2K2)	-25°C ... 60°C
Humidity	10% ... 85% (non condensing)

Condensation during operation must be avoided!

## Functional overview

---

### Noise level (depending on the configuration)

The acoustic noise values are depending on the system configuration.

<b>Standard configuration</b>	
Sound power level $L_{WA,d}$ (ISO 9296)	4.2 B (standby) 4.8 B (operation)
Sound pressure level at adjacent workstation $L_{pAm}$ (ISO 9296)	24 db(A) (standby) 30 db(A) (operation)

### Electrical data: 450 W Platinum

Rated voltage range	100 V - 240 V
Frequency	50 Hz / 60 Hz
Max. rated current	5.0 A - 2.0 A

### Electrical data: 800 W Platinum

Rated voltage range	100 V - 240 V
Frequency	50 Hz / 60 Hz
Max. rated current	9.0 A - 3.5 A

### Electrical data: 1200 W Platinum

Rated voltage range	100-120 V / 200-240 V
Frequency	50 Hz / 60 Hz
Max. rated current	10.5 A (100-120 V) / 5 A (200-240 V)

### Electrical data: 800 W Titanium

Rated voltage range	200 V - 240 V
Frequency	50 Hz / 60 Hz
Max. rated current	4.5 A

**Compliance with standards**

Product safety and ergonomics	
International	IEC 60950-1 2ed.
Europe	
Safety	EN 60950-1 2ed. EN 62479
Ergonomics	EK1-ITB2000
USA / Canada	CSA-C22.2 No. 60950-1-07 2ed.
Taiwan	CNS 14336
China	GB 4943
Electromagnetic compatibility	
International	CISPR 22
Europe	EN 55022 Class A EN 55024 EN 61000-3-2 EN 61000-3-3 ETSI 300386
USA / Canada	47CFR part 15 Class A / ICES-003
Taiwan	CNS 13438 Class A
China	GB 9245 / GB 17625
Japan	VCCI Class A / JEITA
Korea	KN 22 / KN 24
CE marking to EU directives	Low Voltage Directive 2006/95/EC Electromagnetic compatibility 2004/108/EC



**CAUTION!**

This device meets the requirements of Class A CISPR 22/32. This device can cause radio interference in residential areas.



---

## 3 Installation steps, overview

This chapter contains an overview of the steps necessary to install your server. Links take you to sections where you can find more detailed information about the respective steps:

- ▶ First of all, carefully read the safety instructions in ["Important information" on page 33](#) and following.
- ▶ Transport the server to the place where you want to set it up.
- ▶ Unpack the system, check the contents of the package for visible transport damage and check whether the items delivered correspond to the details on the delivery note (see ["Unpacking the server" on page 48](#)).
- ▶ Make sure that you have all necessary manuals (see ["Documentation overview" on page 10](#)); print out the PDF files if required.
- ▶ Components that have been ordered additionally may be delivered loose with the server. For mounting refer to the original component documentation.
- ▶ Mount the server into the rack (see ["Installing/removing the server in/from the rack" on page 50](#)).
- ▶ Set up the floorstand model (see section ["Setting up the floorstand model" on page 49](#)) or install the rack model in the rack (see section ["Installing/removing the server in/from the rack" on page 50](#)).
- ▶ Wire the server. To do this, refer to sections ["Connecting devices to the server" on page 52](#) and ["Notes on connecting/disconnecting cables" on page 59](#).
- ▶ Connect the server to the mains (see ["Connecting the server to the mains" on page 57](#)).
- ▶ Familiarize yourself with the controls and indicators on the front and rear of the server (see section ["Controls and indicators" on page 63](#)).

- ▶ Configure the server and install the desired operating system and applications. The following options are available:

- Remote installation with the ServerView Installation Manager:

With the ServerView Suite DVD provided, you can configure the server and install the operating system in a convenient manner.

Details on how to operate the ServerView Installation Manager, as well as some additional information, are included in the "ServerView Suite Installation Manager" user's guide (on the Fujitsu manuals server under *x86 Servers - Software - ServerView Suite - Server Installation and Deployment*).

Configuration information can also be found in section "[Configuring the server and installing the operating system with the ServerView Installation Manager](#)" on page 81.

- Local configuration and installation with or without the ServerView Installation Manager (see section "[Configuring the server and installing the operating system with the ServerView Installation Manager](#)" on page 81 or section "[Configuring the server and installing the operating system without the ServerView Installation Manager](#)" on page 82).



You will find more information on installing the server remotely or locally in the "ServerView Suite Installation Manager" user's guide (on the Fujitsu manuals server under *x86 Servers - Software - ServerView Suite - Server Installation and Deployment*).



---

## 4 Important information

In this chapter you will find essential information regarding safety when working on your server.



Depending on your server or the installed options some information is not valid for your server.



### **CAUTION!**

Before installing and starting up a server, please observe the safety instructions listed in the following section. This will help you to avoid making serious errors that could impair your health, damage the server and endanger the data base.

### 4.1 Safety instructions



The following safety instructions are also provided in the manual "Safety Notes and Regulations" or "安全上のご注意".

This server meets the relevant safety regulations for IT equipment. If you have any questions about whether you can install the server in the intended environment, please contact your sales outlet or our customer service team.

- The actions described in this manual shall be performed by technical specialists. A technical specialist is a person who is trained to install the server including hardware and software.
- Repairs to the server that do not relate to CSS failures shall be performed by service personnel. Please note that unauthorized interference with the server will void the warranty and exempt the manufacturer from all liability.
- Any failure to observe the guidelines in this manual, and any improper repairs could expose the user to risks (electric shock, energy hazards, fire hazards) or damage the equipment.
- Only valid for non hot-plug components  
Before installing/removing internal components to/from the server, turn off the server, all peripheral devices, and any other connected devices. Also unplug all power cords from the power outlet. Failure to do so can cause electric shock or damage.

## Important information

---

### Before starting up

- During installation and before operating the server, observe the instructions on environmental conditions for your server.
- If the server is brought in from a cold environment, condensation may form both inside and on the outside of the server.

Wait until the server has acclimatized to room temperature and is absolutely dry before starting it up. Material damage may be caused to the server if this requirement is not observed.

- Only transport the server in its original packaging or in packaging that protects it from impacts and jolts.  
In Japan and APAC, transporting the server in its original packaging does not apply.

### Installation and operation

- This server should not be operated in ambient temperatures above 35 °C. For servers with Advanced Thermal Design the ambient temperature can increase to 40 °C or 45 °C.
- If the server is integrated into an installation that draws power from an industrial power supply network with an IEC309 connector, the power supply's fuse protection must comply with the requirements for non-industrial power supply networks for type A connectors.
- The server automatically adjusts itself to a mains voltage, see the type label of your server. Ensure that the local mains voltage lies within these limits.
- This server must only be connected to properly grounded power outlets or connected to the grounded rack internal power distribution server with tested and approved power cords.
- Ensure that the server is connected to a properly grounded power outlet close to the server.
- Ensure that the power sockets on the server and the properly grounded power outlets are easily accessible.
- The On/Off button or the main power switch (if present) does not isolate the server from the mains power supply. In case of repair or servicing disconnect the server completely from the mains power supply, unplug all power plugs from the properly grounded power outlets.

- Always connect the server and the attached peripheral devices to the same power circuit. Otherwise you run the risk of losing data if, for example, the server is still running but a peripheral device (e.g. memory subsystem) fails during a power outage.
- The adequately shielded data cables must be used.

All data and signal cables must have sufficient shielding. The use of cable type S/FTP Cat5 or higher is recommended.  
Use of unshielded or badly shielded cables may lead to increased emission of interference and/or reduced fault-tolerance of the device.
- Ethernet cabling has to comply with EN 50173 and EN 50174-1/2 standards or ISO/IEC 11801 standard respectively. The minimum requirement is a Category 5 shielded cable for 10/100 Ethernet, or a Category 5e cable for Gigabit Ethernet.
- Route the cables in such a way that they do not create a potential hazard (make sure no-one can trip over them) and that they cannot be damaged. When connecting the server, refer to the relevant instructions in this manual.
- Never connect or disconnect data transmission lines during a storm (risk of lightning hazard).
- Make sure that no objects (e.g. jewelry, paperclips etc.) or liquids can get inside the server (risk of electric shock, short circuit).
- In emergencies (e.g. damaged casing, controls or cables, penetration of liquids or foreign bodies), contact the server administrator or your customer service team. Only disconnect the server from the mains power supply if there is no risk of harming yourself.
- Proper operation of the server (in accordance with IEC 60950-1 resp. EN 60950-1) is only ensured if the server is completely assembled and the rear covers for the installation slots have been fitted (electric shock, cooling, fire protection, interference suppression).
- Only install server expansions that satisfy the requirements and rules governing safety and electromagnetic compatibility and those relating to telecommunication terminals. If you install other expansions, they may damage the server or violate the safety regulations. Information on which server expansions are approved for installation can be obtained from our customer service center or your sales outlet.
- The components marked with a warning notice (e.g. lightning symbol) may only be opened, removed or exchanged by authorized, qualified personnel. Exception: CSS components can be replaced.

## Important information

---

- The warranty is void if the server is damaged during installation or replacement of server expansions.
- Only set screen resolutions and refresh rates that are specified in the operating manual for the monitor. Otherwise, you may damage your monitor. If you are in any doubt, contact your sales outlet or customer service center.
- Only valid for non hot-plug components  
Before installing/removing internal components to/from the server, turn off the server, all peripheral devices, and any other connected devices. Also unplug all power cords from the power outlet. Failure to do so can cause electric shock or damage.

Internal devices remain hot after shutdown. Wait for a while after shutdown before installing or removing internal options.

- Do not damage or modify internal cables or internal devices. Doing so may cause a server failure, fire, or electric shock and will void the warranty and exempt the manufacturer from all liability.
- The circuit boards and soldered parts of internal options are exposed and can be damaged by static electricity. To ensure reliable protection, you must wear an earthing band on your wrist when working with this type of module and connect it to an unpainted, conducting metal part of the server.
- Do not touch the circuitry on boards or soldered parts. Hold the metallic areas or the edges of the circuit boards.
- Install the screw removed during installation/detaching internal options in former position. To use a screw of the different kind can cause a breakdown of equipment.
- The procedure of installation on this notes might change depending on a configuration of option.

### Batteries

- Incorrect replacement of batteries may lead to a risk of explosion. The batteries may only be replaced with identical batteries or with a type recommended by the manufacturer.
- Do not throw batteries into the trash can.

Batteries must be disposed of in accordance with local regulations concerning special waste.

- Make sure that you insert the battery the right way round.

- The battery used in this server may present a fire or chemical burn hazard if mistreated. Do not disassemble, heat about 100 °C (212F), or incinerate the battery.
- Replace the lithium battery on the system board in accordance with the instructions in the corresponding Upgrade and Maintenance Manual, chapter "System board and components" > "CMOS battery".
- All batteries containing pollutants are marked with a symbol (a crossed-out garbage can). In addition, the marking is provided with the chemical symbol of the heavy metal decisive for the classification as a pollutant:

Cd Cadmium

Hg Mercury

Pb Lead

### Working with optical disk drives and media

When working with optical disk drives, these instructions must be followed.



#### CAUTION!

- Only use CDs/DVDs/BDs that are in perfect condition, in order to prevent data loss, equipment damage and injury.
- Check each CD/DVD/BD for damage, cracks, breakages etc. before inserting it in the drive.

Note that any additional labels applied may change the mechanical properties of a CD/DVD/BD and cause imbalance and vibrations.

Damaged and imbalanced CDs/DVDs/BDs can break at high drive speeds (data loss).

Under certain circumstances, sharp CD/DVD/BD fragments can pierce the cover of the optical disk drive (equipment damage) and can fly out of the drive (danger of injury, particularly to uncovered body parts such as the face or neck).

- High humidity and airborne dust levels are to be avoided. Electric shocks and/or server failures may be caused by liquids such as water, or metallic items, such as paper clips, entering a drive.
- Shocks and vibrations are also to be avoided.
- Do not insert any objects other than the specified CDs/DVDs/BDs.

## Important information

---

- Do not pull on, press hard, or otherwise handle the CD/DVD/BD tray roughly.
- Do not disassemble the optical disk drive.
- Before use, clean the optical disk tray using a soft, dry cloth.
- As a precaution, remove disks from the optical disk drive when the drive is not to be used for a long time. Keep the optical disk tray closed to prevent foreign matter, such as dust, from entering the optical disk drive.
- Hold CDs/DVDs/BDs by their edges to avoid contact with the disk surface.
- Do not contaminate the CD/DVD/BD surface with fingerprints, oil, dust, etc. If dirty, clean with a soft, dry cloth, wiping from the center to the edge. Do not use benzene, thinners, water, record sprays, antistatic agents, or silicone-impregnated cloth.
- Be careful not to damage the CD/DVD/BD surface.
- Keep the CDs/DVDs/BDs away from heat sources.
- Do not bend or place heavy objects on CDs/DVDs/BDs.
- Do not write with ballpoint pen or pencil on the label (printed) side.
- Do not attach stickers or similar to the label side. Doing so may cause rotational eccentricity and abnormal vibrations.
- When a CD/DVD/BD is moved from a cold place to a warm place, moisture condensation on the CD/DVD/BD surface can cause data read errors. In this case, wipe the CD/DVD/BD with a soft, dry cloth then let it air dry. Do not dry the CD/DVD/BD using devices such as a hair dryer.
- To avoid dust, damage, and deformation, keep the CD/DVD/BD in its case whenever it is not in use.
- Do not store CDs/DVDs/BDs at high temperatures. Areas exposed to prolonged direct sunlight or near heating appliances are to be avoided.



You can prevent damage from the optical disk drive and the CDs/DVDs/BDs, as well as premature wear of the disks, by observing the following suggestions:

- Only insert disks in the drive when needed and remove them after use.
- Store the disks in suitable sleeves.
- Protect the disks from exposure to heat and direct sunlight.

### Laser information

The optical disk drive complies with IEC 60825-1 laser class 1.



#### **CAUTION!**

The optical disk drive contains a light-emitting diode (LED), which under certain circumstances produces a laser beam stronger than laser class 1. Looking directly at this beam is dangerous.

Never remove parts of the optical disk drive casing!

### Modules with Electrostatic-Sensitive Devices (ESD modules)

Modules with electrostatic-sensitive devices are identified by the following sticker:

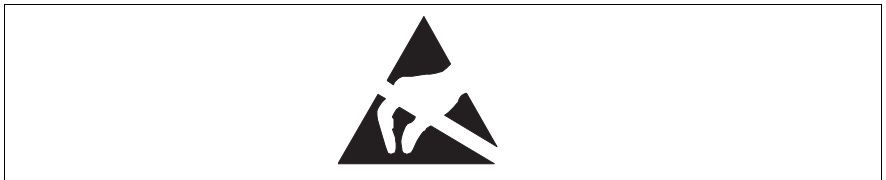

Figure 1: ESD label



The ESD label can be different.

When you handle ESD modules, you must always observe the following points:

- Switch off the server and remove the power plugs from the power outlets before installing or removing ESD modules.

## Important information

---

- The circuit boards and soldered parts of internal options are exposed and can be damaged by static electricity. To ensure reliable protection, you must wear an earthing band on your wrist when working with ESD modules and connect it to an unpainted, conducting metal part of the server.
- Any devices or tools that are used must be free of electrostatic charge.
- Wear a suitable grounding cable that connects you to the external chassis of the server.
- Always hold ESD modules at the edges or at the points marked green (touch points).
- Do not touch any connectors or conduction paths on an ESD module.
- Place all the components on a pad which is free of electrostatic charge.



For a detailed description of how to handle ESD modules, see the relevant European or international standards (EN 61340-5-1, ANSI/ESD S20.20).

## Transporting the server



### CAUTION!

Only transport the server in its original packaging or in packaging that protects it from impacts and jolts.

In Japan and APAC, transporting the server in its original packaging does not apply.

Do not unpack the server until it is at its installation location.

If you need to lift or transport the server, ask other people to help you.

Never lift or carry the server by the handles or the Quick Release Levers (QRLs) on the front panel.



## Notes on installing the server in the rack



### CAUTION!

- For safety reasons, at least 2 people are required to install the server in the rack because of its weight and size.

(For the reader in Japan, please refer to "安全上のご注意".)

- Never lift the server into the rack using the QRLs (Quick Release Levers) on the front panel.
- When connecting and disconnecting cables, observe the relevant instructions in the "Important Information" chapter of the technical manual for the corresponding rack. The technical manual is supplied with the corresponding rack.
- When installing the rack, make sure that the anti-tilt mechanism is correctly fitted.
- Do not extend more than one server out of the rack simultaneously even if the tilt protection is in place. If several servers are simultaneously extended from the rack, there is a risk that the rack could tip over. See the safety information of the rack and the warning label.
- If the server/rack is intended for permanent connection to the mains only an authorized specialist (electrician) is allowed to work. Please follow the regulation of each country.
- If the server is integrated into an installation that draws power from an industrial power supply network with an IEC309 type connector, the power supply's fuse protection must comply with the requirements for non-industrial power supply networks for the type A connector.

## Other important information

- During cleaning, observe the instructions in the corresponding Operating Manual chapter "Starting up and operation" > "Cleaning the server".
- Keep all manuals close to the server. All documentation must be included if the equipment is passed on to a third party.

## 4.2 CE conformity



:The system complies with the requirements of European Regulations. Find the CE declaration on certificate portal:

<https://sp.ts.fujitsu.com/sites/certificates/default.aspx>

To open the CE declaration applicable for your system, proceed as follows:

- ▶ Select *Industry Standard Servers*.
- ▶ Select your model, e.g. *Rack server*.
- ▶ Select your system, e.g. *PRIMERGY RX2530 M1*.
- ▶ Select *CE Cert <your system>*.



### **CAUTION!**

This is a Class A product. In a domestic environment this product may cause RF interference, in which case the user may be required to take adequate measures.

## 4.3 FCC Class A Compliance Statement

If there is an FCC statement on the device, it applies to the products covered in this manual, unless otherwise specified herein. The statement for other products will appear in the accompanying documentation.

### **NOTE:**

This equipment has been tested and found to comply with the limits for a "Class A" digital device, pursuant to Part 15 of the FCC rules and meets all requirements of the Canadian Interference-Causing Equipment Standard ICES-003 for digital apparatus. These limits are designed to provide reasonable protection against harmful interference in a residential installation. This equipment generates, uses and can radiate radio frequency energy and, if not installed and used in strict accordance with the instructions, may cause harmful interference to radio communications. However, there is no warranty that interference will not occur in a particular installation. If this equipment does cause harmful interference to radio or television reception, which can be determined by turning the equipment off and on, the user is encouraged to try to correct the interference by one or more of the following measures:

- Reorient or relocate the receiving antenna.
- Increase the separation between equipment and the receiver.
- Connect the equipment into an outlet on a circuit different from that to which the receiver is connected.
- Consult the dealer or an experienced radio/TV technician for help.

Fujitsu is not responsible for any radio or television interference caused by unauthorized modifications of this equipment or the substitution or attachment of connecting cables and equipment other than those specified by Fujitsu. The correction of interferences caused by such unauthorized modification, substitution or attachment will be the responsibility of the user.

The use of shielded I/O cables is required when connecting this equipment to any and all optional peripheral or host devices. Failure to do so may violate FCC and ICES rules.

### 4.4 Environmental protection

#### Environmentally-friendly product design and development

This product has been designed in accordance with the Fujitsu standard for "environmentally friendly product design and development". This means that key factors such as durability, selection and labeling of materials, emissions, packaging, ease of dismantling and recycling have been taken into account. This saves resources and thus reduces the harm done to the environment.

Further information can be found at:

[http://ts.fujitsu.com/products/standard\\_servers/index.html](http://ts.fujitsu.com/products/standard_servers/index.html)

For the reader in Japan:

<http://jp.fujitsu.com/platform/server/primergy/concept/>

#### Energy-saving information

Devices that do not need to be constantly switched on should be switched off until they are needed as well as during long breaks and after completion of work.

#### Packaging information

This packaging information does not apply in Japan and APAC.

Do not throw away the packaging. You may need it later for transporting the server. If possible, the equipment should only be transported in its original packaging.

#### Information on handling consumables

Please dispose of printer consumables and batteries in accordance with the applicable national regulations.

In accordance with EU directives, batteries must not be disposed of with unsorted domestic waste. They can be returned free of charge to the manufacturer, dealer or an authorized agent for recycling or disposal.

All batteries containing pollutants are marked with a symbol (a crossed-out garbage can). They are also marked with the chemical symbol for the heavy metal that causes them to be categorized as containing pollutants:

Cd Cadmium

Hg Mercury

Pb Lead

### Labels on plastic casing parts

Please avoid sticking your own labels on plastic parts wherever possible, since this makes it difficult to recycle them.

### Returns, recycling and disposal

Please handle returns, recycling and disposal in accordance with local regulations.



The device must not be disposed of with domestic waste. This device is labeled in compliance with European directive 2012/19/EU on waste electrical and electronic equipment (WEEE).

This directive sets the framework for returning and recycling used equipment and is valid across the EU. When returning your used device, please use the return and collection systems available to you. Further information can be found at:

<http://ts.fujitsu.com/recycling>

Details regarding the return and recycling of devices and consumables within Europe can also be found in the "Returning used devices" manual, via your local Fujitsu branch, or at:

<http://ts.fujitsu.com/recycling>



---

## 5 Hardware installation



### CAUTION!

- Follow the safety instructions in the chapter "[Important information](#)" on page 33.
- Do not expose the server to extreme environmental conditions (see "[Ambient conditions](#)" on page 27). Protect the server from dust, humidity and heat.
- Make sure that the server is acclimatized for the time indicated in this table before putting it into operation.

Temperature difference (°C)	Minimum acclimatization time (hours)
5	3
10	5
15	7
20	8
25	9
30	10

Table 1: Acclimatization time

In the [table "Acclimatization time"](#), the temperature difference refers to the difference between the operating environment temperature and the temperature to which the server was exposed previously (outside, transport or storage temperature).

### 5.1 Unpacking the server



#### CAUTION!

Follow the safety instructions in chapter ["Important information" on page 33](#).

The server must always be lifted or carried by at least two people.

For Japan:

Please refer to "安全上のご注意".

Do not unpack the server until it is at its installation location.

- ▶ Transport the server to the place where you want to set it up.
- ▶ Unpack all individual parts.  
Keep the original packaging in case you want to transport the server again (does not apply to Japan).
- ▶ Check the delivery for any damage during transport.
- ▶ Check whether the items delivered match the details on the delivery note.

The product name and serial number of the product can be found on the ID card (see section ["Server front" on page 63](#)).

- ▶ Notify your supplier immediately should you discover that the items delivered do not correspond to the delivery note.
- ▶ Remove all scratching protection foils from the front panel, HDD frames, and PRIMERGY logo, VGA dummy and ODD dummy in case they are still stucked to the server system.



## 5.2 Setting up the floorstand model



If you are not installing a PRIMERGY TX2550 M4 floorstand model, skip this section and continue reading at section ["Installing/removing the server in/from the rack" on page 50](#).



### CAUTION!

Please note the safety instructions in chapter ["Important information" on page 33](#).

- ▶ Transport the server to the place where you want to set it up.
- ▶ Unpack the server (see section ["Unpacking the server" on page 48](#)).
- ▶ Set up the server.



### CAUTION!

- The device must be protected from direct sunlight.
  - The required minimum distances for operation and maintenance areas must be adhered to.
  - The server must be accessible at the rear for connection to other devices (e.g. memory subsystem).
  - The mains plug must be accessible easily and safely.
  - There must be a clearance of at least 200 mm in front of and behind the server to ensure adequate ventilation of the subsystem.
- ▶ Wire the server. Read the information in section ["Connecting devices to the server" on page 52](#) and section ["Notes on connecting/disconnecting cables" on page 59](#).
  - ▶ Connect the system to the mains (see section ["Connecting the server to the mains" on page 57](#)).

## 5.3 Installing/removing the server in/from the rack



### CAUTION!

- Please observe the safety information and notes on rack mounting in chapter "Important information" on page 33 and section "Notes on installing the server in the rack" on page 41.
- At least two people are needed to install / remove the server in the rack. (For Japan, please refer to "安全上のご注意".)
- Do not extend more than one unit out of the rack simultaneously even if the tilt protection is in place. If several units are simultaneously extended out of the rack, there is a risk that the rack could tip over.

### Fujitsu rack systems

The rack systems from Fujitsu support the installation of PRIMERGY servers:

- PRIMECENTER rack
- PRIMECENTER M1 rack
- DataCenter rack
- 19-inch standard rack (for Japan)
- 19-inch slim rack (for Japan)



For information on mounting the server in the rack please refer to the Mounting Instructions provided with the Rack Mounting Kit. Further information you find in the manual of your rack system.

For Japan, please refer also to the "Rack system structure guide."



Online documentation for rack installation can be found on:

<http://manuals.ts.fujitsu.com/index.php?id=5406-5605-5606>

For Japan:

[http://jp.fujitsu.com/platform/server/primergy/manual/peri\\_rack.html](http://jp.fujitsu.com/platform/server/primergy/manual/peri_rack.html)

To accommodate the ventilation concept and ensure proper ventilation, any unused areas in the rack must be sealed using dummy covers.

The power is supplied via the multiple socket outlets fitted in the rack (not valid for Japan).

The main features of Fujitsu rack systems are as follows:

- rail systems that can be mounted without tools

- support systems having a linear alignment feature to ensure that they can be adjusted to different rack depths

Asymmetrical PRIMECENTER Rack and DataCenter Rack provide an enhanced cable management in the lateral rack area.

### 3rd party racks



Installation in most current rack systems from other manufacturers (3rd party racks) is also supported. For details please contact your sales representative.

## 5.4 Connecting devices to the server

The connectors for external devices are on the front and rear of the server. The additional connectors available on your server depend on the expansion cards installed. For further information refer to the "FUJITSU Server PRIMERGY TX2550 M4 Server Upgrade and Maintenance Manual".

Two additional USB connectors (1) are located on the front of the server ([figure 2 on page 52](#)).



Figure 2: Front side connectors

1	2x USB 3.0 connectors
---	-----------------------

## 2.5-inch HDD/SSD model

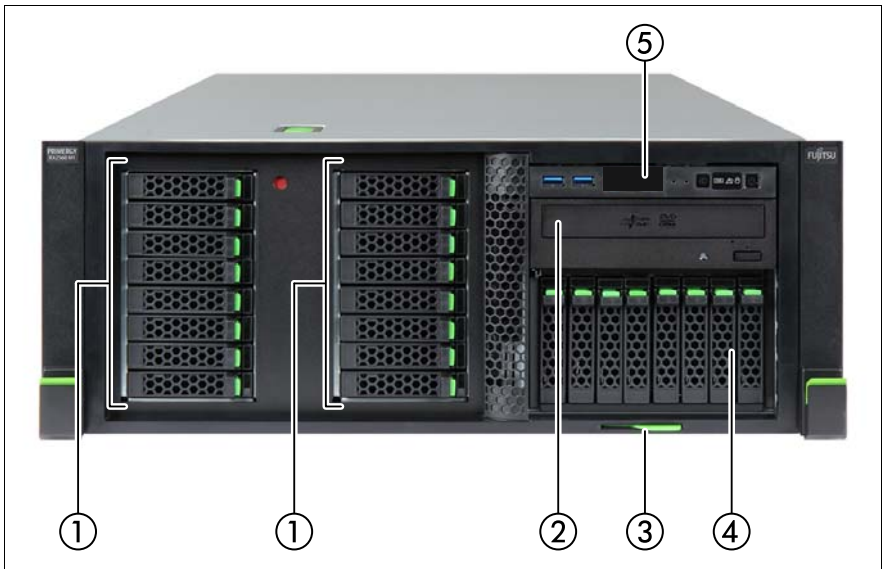

Figure 3: Server front 2.5-inch HDD/SSD model - example TX2550 M4 (rack model)

Pos.	Component
1	2.5-inch HDDs / SSDs / dummy modules
2	ODD / 5.25-inch dummy module
3	ID card
4	8x 2.5-inch HDD extension box / 8x 2.5-inch PCIe SSD extension box
5	Front panel module

## 3.5-inch HDD model

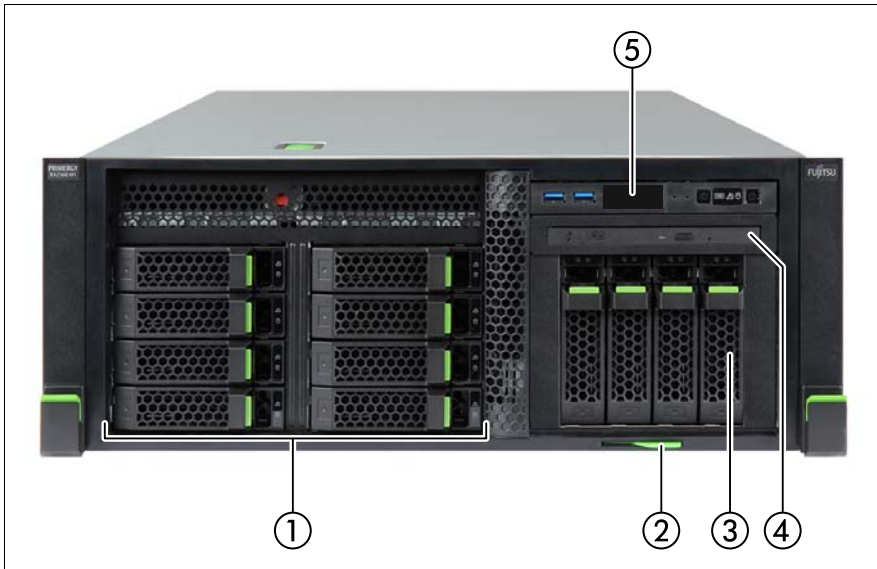

Figure 4: Server front 3.5-inch HDD model - example TX2550 M4 (rack model)

Pos.	Component
1	3.5-inch HDDs / dummy modules
2	ID card
3	4x 3.5-inch HDD extension box
4	ODD
5	Front panel module

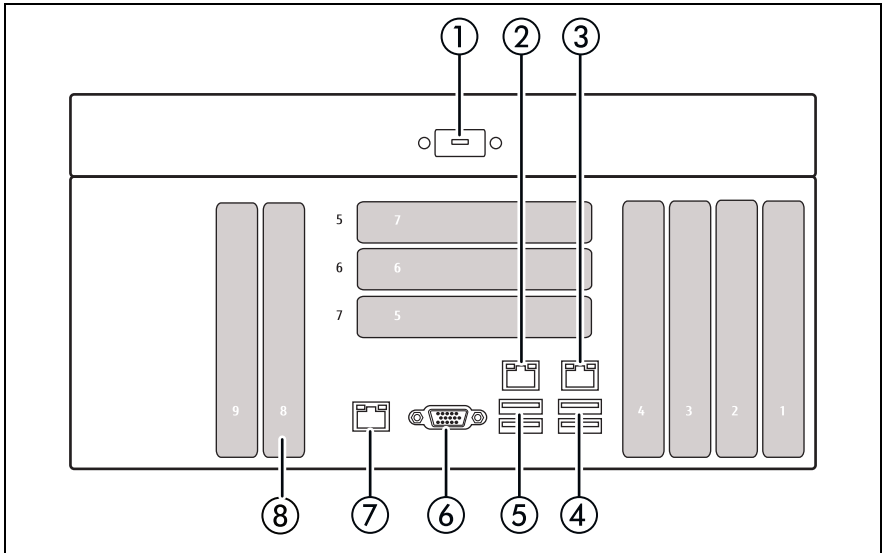

Figure 5: Connector panel

1	Serial connector (optional)*	5	2 USB connectors (USB 3.0)
2	Shared LAN connector	6	Video connector (VGA)
3	LAN connector	7	Management LAN connector (for iRMC S5 server management function)
4	2 USB connectors (USB 3.0)	8*	Dedicated slot for OCP modules

\* When using an OCP module, the standard PCIe x16 slot is not usable.

The corresponding indicators are explained in section ["Server rear" on page 70](#).

**i** Some of the devices connected require special software (e.g. drivers) (see documentation for the connected device).

**i** The LAN connectors on the OCP modules are numbered in ascending order from right to left beginning with "0". The rightmost connector (LAN 0) is the shared LAN connector respectively.

► Connect the devices.

### Connecting the keyboard, mouse and monitor

- ▶ Connect the monitor, the keyboard and the mouse to the standard ports of the server.
- ▶ Connect the power cable of the monitor to a grounded mains outlet of the in-house mains and/or to the mains socket strip of the rack.



#### **CAUTION!**

The rated current for the monitor is indicated on the technical data label on the monitor or in the operating manual for the monitor.



## 5.5 Connecting the server to the mains

In its basic configuration level the server has a hot-plug PSU.

A second hot-plug PSU can be added to ensure a redundant power supply. If one PSU is defective, the other then guarantees unimpaired operation. Each hot-plug PSU can be replaced during operation (see the "FUJITSU Server PRIMERGY TX2550 M4 Server Upgrade and Maintenance Manual").



### CAUTION!

The server is automatically set to a mains voltage range of:

- 100 V to 240 V, valid for Platinum 450 W and Platinum 800 W
- 200 V to 240 V, valid for Titanium 800 W

You may only operate the server if its rated voltage range corresponds to the local mains voltage.

- ▶ Connect the power cord to the server PSU.
- ▶ Connect the power cord to a grounded mains outlet in the in-house power supply network or a power outlet of the socket strip in the rack.



A phase redundancy in the power supply of the server can be set up if two hot-plug PSUs are installed.

In this case, each of the PSUs is either connected to two different phases or to two separate circuits of the internal power supply network.

### 5.5.1 Using the cable clamp

You can secure power cords in a cable clamp to ensure that the insulated connectors cannot be disconnected from the server accidentally.

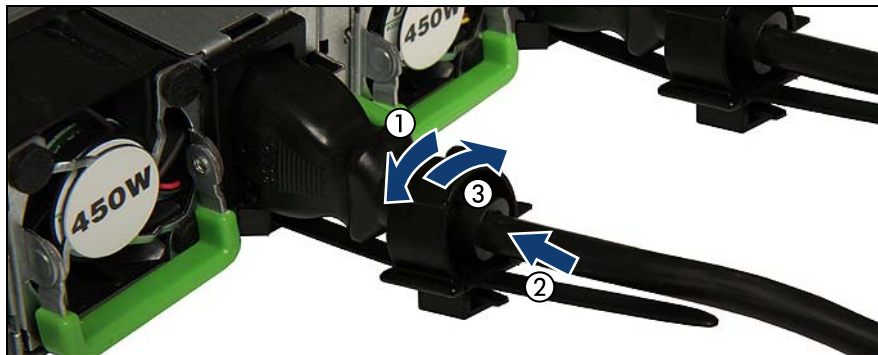

Figure 6: Cable clamp

- ▶ Pull the cable clamp up (1).
- ▶ Thread the power cord through the cable clamp (2).
- ▶ Press the cable clamp down until it engages to secure the cable (3).

## 5.6 Notes on connecting/disconnecting cables



### CAUTION!

Always read the documentation supplied with the device you wish to connect.

Never connect, or disconnect cables during a thunderstorm.

Never pull on a cable when disconnecting it. Always take hold of the cable by the plug.

Follow the sequence described below to connect or disconnect external devices to or from the server:

Be sure to wait for 10 seconds or more after shutdown before turning the server on.

### Connecting cables

- ▶ Turn off all power and equipment switches.
- ▶ Disconnect all power plugs from the properly grounded power outlets.
- ▶ Connect all cables to the server and peripherals.
- ▶ Plug all data communication cables into the utility sockets.
- ▶ Plug all power cords into the properly grounded power outlets.

### Disconnecting cables

- ▶ Turn off all power and equipment switches.
- ▶ Disconnect all power plugs from the properly grounded power outlets.
- ▶ Unplug all data communication cables from the utility sockets.
- ▶ Disconnect the relevant cables from the server and all the peripherals.



For connecting or disconnecting LAN cables, the server does not need to be powered off. To avoid loss of data teaming function has to be enabled.

### Information for ensuring electromagnetic compatibility

All data and signal cables must have sufficient shielding. The use of cable type S/FTP Cat5 or higher is recommended.

Use of unshielded or badly shielded cables may lead to increased emission of interference and/or reduced fault-tolerance of the device.



---

## 6 Starting up and operation



### CAUTION!

Follow the safety instructions in chapter "[Important information](#)" on [page 33](#).

### 6.1 Access to the drives (floorstand model)

#### 6.1.1 Enabling access to the accessible drives



Figure 7: Removing the drive cover and placing it on the HDD cover

- ▶ Unlock the server (1).
- ▶ Remove the drive cover (2).
- ▶ Place the accessible drive bay as shown (3).
- ▶ Push down the drive cover in the direction of the arrow (4).



Please note the following when operating with tape drives:

If the system is programmed to eject the media automatically, the accessible drives must not be obstructed.

The drive cover is replaced and the server locked in the reverse order.

### 6.1.2 Access to the HDD modules (floorstand model)



Figure 8: Removing the HDD cover

- ▶ Unlock the server (1).
- ▶ Remove the HDD/SSD cover (2).

The HDD/SSD cover is replaced and the server locked in the reverse order.

## 6.2 Controls and indicators

### 6.2.1 Server front

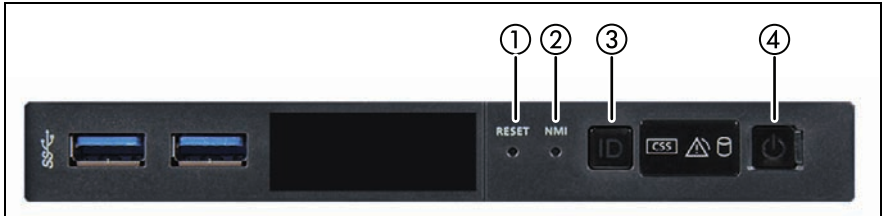





Figure 9: Controls on the front panel

#### 6.2.1.1 Controls on the front panel

Pos.	Label	Button	Function
1	<b>RESET</b>	Reset button	Reboots the system. Press the reset button with a straightened end of a paper clip.  <b>CAUTION!</b> Risk of data loss!
2	<b>NMI</b>	NMI button	Used to troubleshoot software and device driver errors. Press the NMI button with a straightened end of a paper clip.  <b>CAUTION!</b> Use this button only if directed to do so by qualified certified maintenance personnel!
3	<b>ID</b>	ID button	Highlights the ID indicator on the front and I/O panels for easy server identification.

## Starting up and operation

---

Pos.	Label	Button	Function
4		On/Off button	Used to switch the server on or off.  If the system is running an ACPI-compliant operating system, pressing the On/Off button will perform a graceful shutdown.



## 6.2.1.2 Indicators on the front panel

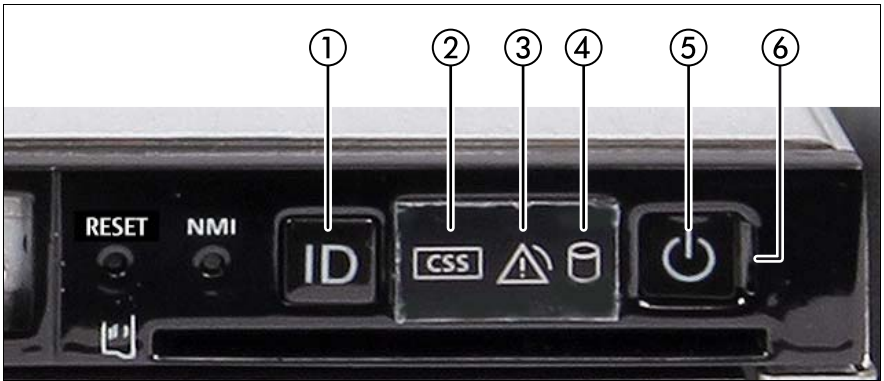





Figure 10: Indicators on the front panel

Pos.	Label	Indicator	Status	Description
1	ID	ID indicator, see also <a href="#">"iRMC-related status signals" on page 67</a>	blue on	The server has been highlighted using ServerView Operations Manager, iRMC web interface or the ID button on the front panel for easy identification.
			blue flashing	The server has been highlighted for easy identification using the iRMC (AVR) with disabled local VGA output.
2	CSS	CSS indicator	off	No critical event detected (CSS component).
			orange on	Prefailure event detected (CSS component).
			orange flashing	CSS component failure detected.

## Starting up and operation

Pos.	Label	Indicator	Status	Description
3		Global Error indicator, see also "iRMC-related status signals" on page 67	off	No critical event detected (non CSS component).
			orange on	Prefailure event detected (non CSS component).
			orange flashing	Non CSS component failure detected. Possible causes: <ul style="list-style-type: none"> <li>– System is out of the specified temperature range</li> <li>– Defective sensor</li> <li>– CPU error</li> <li>– Error detected by server management software</li> </ul>
4		HDD/SSD activity indicator	green flashing	Data access in progress.
5		Power-on indicator	off	The server is switched off.
			green on	<ul style="list-style-type: none"> <li>– The server has been switched on but Power Cycle Delay settings delay it from turning on for a specified time.</li> <li>– The server is switched on and operating normally.</li> </ul>
			green flashing slowly	The iRMC firmware is starting up after the server has been connected to the mains.

Pos.	Label	Indicator	Status	Description
6		AC connected indicator	green on	<ul style="list-style-type: none"> <li>– The server is switched off and connected to the mains (standby mode).</li> <li>– The server has been switched on but Power Cycle Delay settings delay it from turning on for a specified time.</li> </ul> <div style="border: 1px solid black; padding: 2px; display: inline-block; margin-top: 10px;"> <b>i</b> After connecting the server to the mains, it will take about 60 seconds until the server will enter standby mode and can be switched on.         </div>
			off	<ul style="list-style-type: none"> <li>– The server is switched off and not connected to the mains.</li> <li>– The server is switched on and operating normally.</li> </ul>

#### iRMC-related status signals

ID indicator	Global error indicator	Description
blue flashing	off	A remote connection has been established. Local VGA output has been disabled during the remote session.
blue flashing	orange flashing	<p>An emergency flash of the iRMC firmware is in progress.</p> <div style="border: 1px solid black; padding: 2px; display: inline-block; margin-top: 10px;"> <b>i</b> For further information on the emergency flash of the iRMC firmware, refer to the "FUJITSU Server PRIMERGY TX2550 M4 Upgrade and Maintenance Manual".         </div>

### 6.2.1.3 Indicator on the ODD

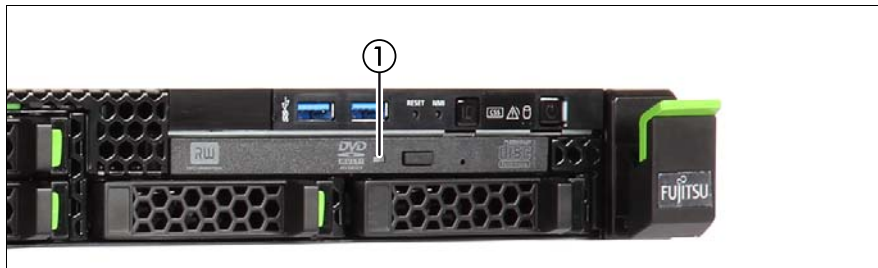

Figure 11: Example: Indicator on the ODD

Pos.	Indicator	Status	Description
1	Activity indicator	off	The ODD is inactive.
		green on	The storage medium is being accessed.



There are also ODDs without activity indicators.

## 6.2.1.4 Indicators on the hot-plug HDD/SSD module

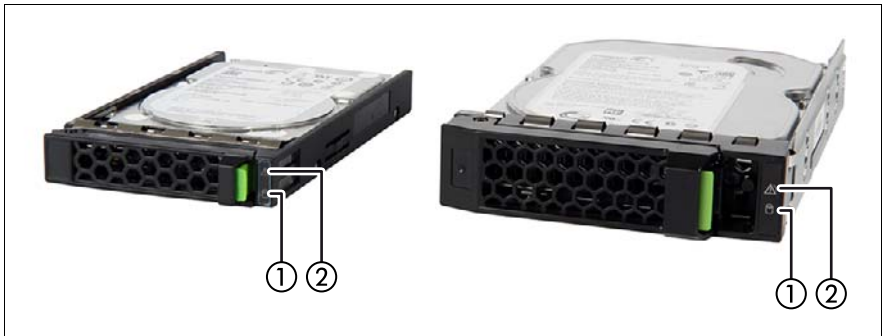



Figure 12: Indicators on the hot-plug HDD/SSD module

Pos.	Label	Indicator	Status	Description
1		Access indicator	off	The HDD/SSD is inactive.
			green on	The HDD/SSD being accessed
2		Error indicator	off	No HDD/SSD error detected.
			orange on	An HDD/SSD error has been detected. Possible causes: <ul style="list-style-type: none"> <li>– The drive is defective and needs replacing.</li> <li>– A RAID rebuild process has failed.</li> <li>– The HDD/SSD module has not been inserted correctly.</li> </ul>
			orange flashing slowly	RAID rebuild is in progress. Data is being restored after replacing a drive that has been combined into a RAID array.

## 6.2.2 Server rear

### 6.2.2.1 Indicators on the I/O panel

#### ID, CSS and Global Error indicators



Figure 13: ID, CSS and Global Error indicators

Pos.	Indicator	Status	Description
1	ID indicator, see also "iRMC- related status signals" on page 67	blue on	The server has been highlighted using ServerView Operations Manager, iRMC web interface or the ID button on the front panel for easy identification.
		blue flashing	The server has been highlighted for easy identification using the iRMC (AVR) with disabled local VGA output.
	Global Error indicator, see also "iRMC- related status signals" on page 67	off	No critical event detected (non CSS component).
		orange on	Prefailure event detected (non CSS component).
		orange flashing	Non CSS component failure detected. Possible causes: <ul style="list-style-type: none"> <li>– System is out of the specified temperature range</li> <li>– Defective sensor</li> <li>– CPU error</li> <li>– Error detected by server management software</li> </ul>
	CSS indicator	off	No critical event detected (CSS component).
		orange on	Prefailure event detected (CSS component).
		orange flashing	CSS component failure detected.



*Note on CSS and Global Error indicators on the I/O panel*

If CSS and Global Error indicators are located in the same place on your server's I/O panel, please also check the indicators on the front panel to determine if a CSS or Global Error event has been detected.



For further details on detected errors, refer to the System Event Log (SEL) or use the ServerView Operations Manager or iRMC S5 web interface.

### iRMC-related status signals

ID indicator	Global error indicator	Description
blue flashing	off	A remote connection has been established. Local VGA output has been disabled during the remote session.
blue flashing	orange flashing	<p>An emergency flash of the iRMC firmware is in progress.</p> <p> For further information on the emergency flash of the iRMC firmware, refer to the "FUJITSU Server PRIMERGY TX2550 M4 Upgrade and Maintenance Manual".</p>



LAN indicators

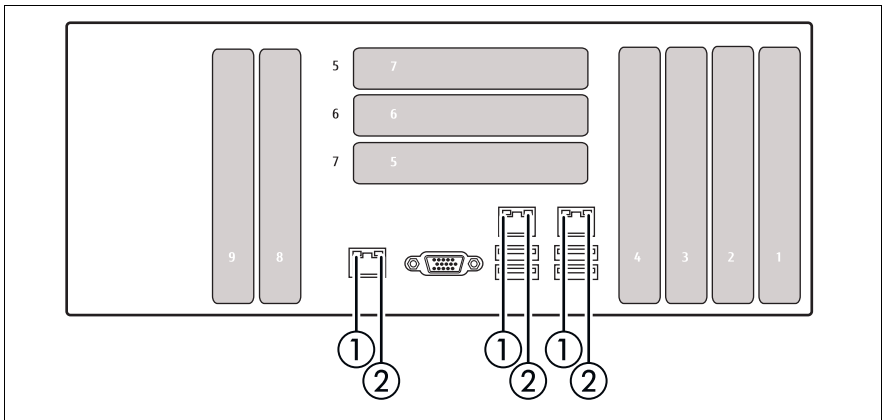

Figure 14: LAN indicators

Pos.	Indicator	Status	Description
1	LAN link / transfer indicator	green on	LAN connection established
		off	no LAN connection
		green flashing	data transfer in progress
2	LAN speed indicator	yellow on	traffic a transfer rate of 1 Gbit/s
		green on	traffic a transfer rate of 100 Mbit/s
		off	traffic a transfer rate of 10 Mbit/s

### 6.2.2.2 Indicators on PSUs (slide-in units)

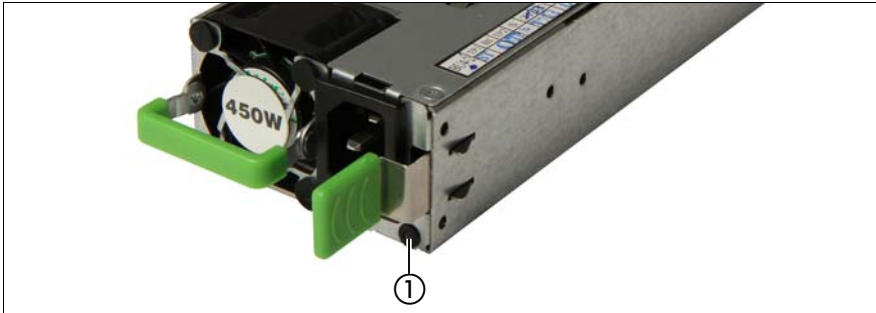

Figure 15: PSU status indicator (AC PSU)

Pos.	Indicator	Status	Description
1	PSU status indicator	green flashing	The server is switched off, but mains voltage is present (standby mode).
		green on	The server is switched on and operating properly.
		orange flashing	An overload has been detected. The PSU is still running, but failure might be imminent.
		orange on	An PSU failure has been detected. Possible causes: <ul style="list-style-type: none"><li>– Over/under voltage</li><li>– Overheating</li><li>– Fan failure</li></ul>

## 6.3 ID card



Figure 16: ID card

You can pull out the ID card as far as it will go and push it back again.

The ID card contains various system information, such as the product name, serial number, order number, MAC addresses and DNS name (for Japan, only the product name and the serial number).

### 6.4 Switching the server on and off



#### CAUTION!

- If nothing appears on the screen but flickering stripes after switching on the server, switch the server off immediately (see chapter "[Troubleshooting and tips](#)" on page 87).
- The On/Off button does not disconnect the server from the mains voltage. To completely disconnect it from the mains voltage, remove the power plug(s) from all PSU inlet connectors.
- Do not move, strike, or shake the server when it is turned on. This can damage the HDD in the server and cause data loss.
- Turn the server on when the temperature is within its operating environment range (10–35°C). For details on the operating environment, refer to "Safety Precautions". When operating the device outside of this operating environment, the server may operate improperly and data loss may occur. Furthermore, Fujitsu cannot be held responsible for any related damage, malfunction, or loss of data, etc.
- Be sure to wait for 10 seconds or more after shutdown before turning the server on again.
- After connecting all power cords, wait at least 10 seconds before pressing the On/Off button.

#### Switching the server on

The AC connected indicator lights up green (standby mode) when the server is connected to the mains.



It will take about 60 seconds until the server can be powered on.

### – Starting up for the first time:

For Japan, please refer to "はじめにお読みください".

- ▶ Press the On/Off button.
- ▶ Insert ServerView Suite Installation DVD in the ODD.
- ▶ Follow the on-screen instructions (see also section "[Configuring the server and installing the operating system with the ServerView Installation Manager](#)" on page 81 or section "[Configuring the server and installing the operating system without the ServerView Installation Manager](#)" on page 82).

### – System already installed:

- ▶ Press the On/Off button.

The server is switched on, performs a system test and boots the operating system.



In the case of configurations with a large memory size, the boot process may be prolonged and the screen may remain dark for several minutes.

### Switching the server off

The Power-on indicator (see [figure 9 on page 63](#)) lights up green.

- ▶ Shut down the operating system properly.

The server is switched off automatically and enters standby mode. The power-on indicator lights up green.



If the operating system does not switch off the server automatically, press the On/Off button for at least four seconds and/or send a corresponding control signal for power button override.

### Other On/Off options

Besides the On/Off button, the server can be switched ON and OFF in the following ways:

#### – Timer-controlled switch-on/off

Using the ServerView Operations Manager or iRMC S5, you can configure that the server is switched on/off controlled by an internal timer.

### – Ring indicator

The server is switched on by an internal or external modem.

### – Wake up On LAN (WOL)

The server is switched on by a command via the LAN (Magic Packet™).

### – After power failure

The server automatically reboots following a power failure (depending on the settings in the BIOS or in iRMC S5).

### – Power button override

The system can be switched off (hard power off) by keeping the On/Off button (approximately 4 - 5 seconds).



#### **CAUTION!**

There is a risk that data may be lost.

### – iRMC S5

iRMC S5 offers various options for switching the server on and off, e.g. via the *Power On Off* page of the iRMC S5 Web interface.



#### **CAUTION when turning the power off!**

The operation of the power switch can be specified as "Do Nothing", "Stand by", "Hibernate", and "Shutdown" depending on the OS settings. The default is "Shutdown".

On this server, functions corresponding to "Stand by" and "Hibernate" are supported as BIOS and hardware functions. However, some drivers and software installed in the server do not support these functions. For this reason, functions corresponding to "Stand by" and "Hibernate" are unavailable on this server. When the operating mode is set to "Stand by" or "Hibernate", the system may operate improperly or HDD data may be corrupted.

For details about operating mode settings, refer to the manual supplied with the OS.



## 6.5 Configuring the server

This section contains information about configuring the server and installing the operating system.

-  Make sure that the power saving functions are disabled in the *Power* menu of the BIOS setup during operation.

### 6.5.1 Configuring the onboard SATA controller

A SATA controller is integrated on the system board. You can configure the onboard controller either before or during installation with the ServerView Installation Manager. Using the ServerView Installation Manager is recommended.

-  The controller has its own configuration utility. For further information, refer to the “Embedded MegaRAID Software User’s Guide” (on the Fujitsu manuals server under *x86 Servers - Expansion Cards - Storage Adapters - LSI SAS / SCSI RAID Controllers*).
-  Descriptions of operating systems not covered in the controller manual are provided in the corresponding readme under:  
<http://www.fujitsu.com/global/services/computing/server/ia/driver/index.html>  
For Japan:  
<http://www.fmworld.net/cgi-bin/drviasearch/drviaindex.cgi>.
-  In the system BIOS the onboard SAS/SATA controller can be configured as "RAID" (default) or "non-RAID".

### 6.5.2 Configuring the SAS/SATA RAID controller (PCIe expansion card)

The server has a SAS/SATA RAID controller with "MegaRAID functionality". You can configure the SAS/SATA RAID controller either before or during installation with the ServerView Installation Manager. Using the ServerView Installation Manager is recommended.

**i** A separate utility is available to the controller for MegaRAID configuration. For further information, refer to the "SAS Software User's Guide" (on the Fujitsu manuals server under *x86 Servers - Expansion Cards - Storage Adapters - LSI Configuration Software*).

Further information on modular RAID controllers is provided in the "Modular RAID Controller Installation Guide" (on the Fujitsu manuals server under *x86 Servers - Expansion Cards - Storage Adapters - LSI SAS / SCSI RAID Controllers*).

**i** Descriptions of operating systems not covered in the controller manual are provided in the corresponding readme under:

For the global market:

<http://www.fujitsu.com/global/services/computing/server/ia/driver/index.html>

For Japan:

<http://www.fujitsu.com/jp/products/computing/servers/primergy/downloads/>





### 6.5.3 Configuring the server and installing the operating system with the ServerView Installation Manager

Using the ServerView Installation Manager on the ServerView Suite DVD provided, you can conveniently configure the server and install the operating system. This includes configuring the server-specific settings using the ServerView Configuration Manager and configuring the RAID controller using the **ServerView RAID Manager**.

#### Advantages of the ServerView Installation Manager

- Wizard assisted configuration of your server hardware and disk arrays
- Wizard assisted installation of all leading server operating systems
- Wizard-assisted creation of configuration files for unattended installation of several PRIMERGY servers with identical hardware configurations.
- Installation of drivers and additional software.

 The software that can be installed depends on your server's hardware configuration. This configuration is detected automatically.

 Descriptions of operating systems not covered in the RAID controller manual are provided in the corresponding readme files under:  
<http://www.fujitsu.com/global/services/computing/server/ia/driver/index.html>

For Japan:

<http://www.fujitsu.com/jp/products/computing/servers/primergy/downloads/>

To find out how to operate the ServerView Installation Manager and for further information, refer to the associated manual.

If you are using the ServerView Installation Manager, you can skip the following section on how to configure the server and install the operating system. Continue from section "[Cleaning the server](#)" on page 83.

### 6.5.4 Configuring the server and installing the operating system without the ServerView Installation Manager

#### **Configuring the SAS/SATA RAID controller with "Integrated Mirroring Enhanced"**

Configure the controller as described in section ["Configuring the SAS/SATA RAID controller \(PCIe expansion card\)"](#) on page 80.

#### **Configuring SAS/SATA RAID controller with "MegaRAID functionality"**

Configure the controller as described in section ["Configuring the SAS/SATA RAID controller \(PCIe expansion card\)"](#) on page 80.

#### **Installing the operating system**

- ▶ Insert the CD/DVD for the operating system you want to install.
- ▶ Reboot the server.
- ▶ Follow the instructions on screen and in the manual for the operating system.

## 6.6 Cleaning the server



### **CAUTION!**

Switch off the server and disconnect the power plugs from the properly grounded power outlets.

Do not clean any interior parts yourself; leave this job to a service technician.

Do not use any cleaning agents that contain abrasives or may corrode plastic.

Ensure that no liquid enters the system. Ensure that the ventilation areas of the server and the monitor are clear.

Do not use any cleaning sprays (including flammable types). It may cause a device failure or a fire.

Clean the keyboard and the mouse with a disinfecting cloth.

Wipe the server and monitor casing with a dry cloth. If particularly dirty, use a cloth that has been moistened in a mild domestic detergent and then carefully wrung out.



---

## 7 Property and data protection

The floorstand model is protected against unauthorized opening by a lock. Apart from this, the server is also fitted with two intrusion detection switches which enable the ServerView Operations Manager to detect and log any removal of the housing cover and the cover for the HDD/SSD modules.

To prevent that the server is being removed from its location, the floorstand model can be secured to a fixed object with a steel cable running through a clip on the back.

The rack model is protected against unauthorized access by a lockable rack door.

To protect your system and data internally against unauthorized access, you can use the BIOS setup security functions.

### 7.1 BIOS setup security functions

The *Security* menu in BIOS setup offers various options for protecting your data from unauthorized access. By combining these options, you can also achieve optimum protection for your system.



A detailed description of the *Security* menu and how to assign passwords can be found in the "D3386 BIOS setup Utility for FUJITSU Server PRIMERGY TX2550 M4 Reference Manual".



---

## 8 Troubleshooting and tips



### CAUTION!

Follow the safety instructions in the chapter "Safety notes and regulations" manual or "安全上のご注意" and in chapter "[Important information](#)" on page 33.

If a fault occurs, attempt to resolve it using the measures described:

- in this chapter,
- in the documentation for the connected devices,
- in the help systems of the software used.

If you fail to correct the problem, proceed as follows:

- ▶ Make a list of the steps performed and the circumstances that led to the fault. Also make a list of any error messages that were displayed.
- ▶ Switch off the server.
- ▶ Contact our customer service team.

### 8.1 Power-on indicator remains unlit

The power-on indicator remains dark after you switch on your device.

#### Power cable incorrectly connected

- ▶ Make sure that the power cable(s) is/are correctly connected to the server and the grounded power outlet(s).

#### Power supply overloaded

- ▶ Disconnect the server power plug(s) from the grounded power outlet(s).
- ▶ Wait a few minutes before you plug it/them into the grounded power outlet(s) again.
- ▶ Switch on your server.

### 8.2 Server switches itself off

#### Server Management has detected an error

- ▶ Check the error list of System Event Log in ServerView Operations Manager or in the iRMC web interface, and attempt to eliminate the error.

### 8.3 Screen remains blank

#### Monitor is switched off

- ▶ Switch on your monitor.

#### Screen has gone blank

- ▶ Press any key on the keyboard.  
or
- ▶ Deactivate screen saver. Enter the appropriate password.

#### Brightness control is set to dark

- ▶ Set the brightness control on the monitor to light. For detailed information, refer to the operating manual supplied with your monitor.

#### Power cable or monitor cable not connected

- ▶ Switch off the monitor and the server.
- ▶ Check whether the power cable is properly connected to the monitor and to the grounded power outlet.
- ▶ Check whether the monitor cable is properly connected to the server and monitor (if it is plugged in with a connector). If a separate graphics card is installed in the server, then the monitor cable must be connected to the graphics card.
- ▶ Switch on the monitor and the server.



## 8.4 Flickering stripes on monitor screen



### CAUTION!

Switch off the server immediately. Risk of damaging the server.

### Monitor does not support the set horizontal frequency

- ▶ Find out which horizontal frequency your monitor screen supports. You will find the horizontal frequency (also known as line frequency or horizontal deflection frequency) in the documentation for your monitor.
- ▶ Refer to the documentation for your operating system or the software for the screen controller for details of how to set the correct horizontal frequency for your monitor, and follow the procedure accordingly.

## 8.5 No screen display or display drifts

### The wrong horizontal frequency or resolution has been selected for the monitor or for the application program.

- ▶ Find out which horizontal frequency your monitor screen supports. You will find the horizontal frequency (also known as line frequency or horizontal deflection frequency) in the documentation for your monitor.
- ▶ Refer to the documentation for your operating system or the software for the screen controller for details of how to set the correct horizontal frequency for your monitor, and follow the procedure accordingly.

## 8.6 No mouse pointer displayed on screen

### Mouse driver not loaded

- ▶ Check whether the mouse driver is properly installed and is activated when the application program is started. Detailed information can be found in the user manuals for the mouse, the operating system and the application program.

### 8.7 System will not boot

The system will not boot after installing a new hard disk drive.

#### SAS configuration incorrect

- ▶ Check the settings for the hard disk drives (SAS Device Configuration) and the additional settings in the SAS configuration menu.

### 8.8 Incorrect date and time

- ▶ Set the date and time in the operating system or in the BIOS Setup under the Main menu, using System Date and System Time respectively.



Note that the operating system may affect the system time. For example, the operating system time may deviate from the system time under Linux, and would overwrite the system time in the default setting on shutdown.

If the date and time are still wrong after the server has been switched off and back on again, replace the lithium battery (for a description refer to the "FUJITSU Server PRIMERGY TX2550 M4 Upgrade and Maintenance Manual") or contact our customer service team.

## 8.9 Hard disk drive error messages at system boot

Various hard disk drive error messages may occur when the system is rebooted. These error messages are caused by modifications in the selected RAID configuration.

### RAID controller configuration incorrect

- ▶ Check and correct the settings for the drives using the RAID controller configuration program.



Further information is provided in the "Integrated RAID for SAS User's Guide" (on the Fujitsu manuals server under *x86 Servers - Expansion Cards - Storage Adapters - LSI RAID / SCSI Controllers*) or in the "Modular RAID Controller Installation Guide" (on the Fujitsu manuals server under *x86 Servers - Expansion Cards - Storage Adapters - LSI RAID / SCSI Controllers*).

For more information on configuring the controller, see section ["Configuring the server" on page 79](#).

### 8.10 Added drive reported as defective

#### RAID controller is not configured for this drive

The drive was probably installed when the system was switched off.

- ▶ Reconfigure the RAID controller for the drive using the corresponding utility. Information is provided in the documentation for the RAID controller.

or

- ▶ Remove and reinstall the drive while the system is switched ON.

If the hard disk drive continues to be shown as defective, then replace it (see the "FUJITSU Server PRIMERGY TX2550 M4 Server Upgrade and Maintenance Manual").



Further information is provided in the "Integrated RAID for SAS User's Guide" (on the Fujitsu manuals server under *x86 Servers - Expansion Cards - Storage Adapters - LSI RAID / SCSI Controllers*) or in the "Modular RAID Controller Installation Guide" (on the Fujitsu manuals server under *x86 Servers - Expansion Cards - Storage Adapters - LSI RAID / SCSI Controllers*).

For more information on configuring the controller, see section ["Configuring the server" on page 79](#).

### 8.11 Error message on screen

The meaning of the error message is explained in the documentation for the relevant components and programs on the Fujitsu manuals server.

### 8.12 Expansion cards or onboard devices not recognized

When an expansion card is added, other expansion cards or onboard devices might not be recognized.

- ▶ Reinstall the drivers for the expansion cards or onboard devices that are not recognized.

## 8.13 Temperature warning

A temperature warning is output to the hardware event log and OS event log, or ServerView issues a notification of a temperature warning such as by a popup message

The above log is output or the above notification is issued by ServerView when the ambient temperature exceeds the upper limit of the temperature boundaries. The upper limit is 35°C for standard server and 40°C or 45°C with Advanced Thermal Design.

- ▶ Although continued use within the temperature boundaries poses no problems within itself, reconsider the surrounding environment conditions if this log is output or if ServerView issues this notification.

## 8.14 No effect of keyboard or mouse

Typing the keyboard does not display any characters, or the mouse cursor does not move.

- ▶ Check to see whether the keyboard and mouse are connected properly. If they are not connected or you replaced them yourself, then connect the cables to the server.

## 8.15 Optical drive cannot read data

- ▶ Check to see whether the CD/DVD/BD is inserted properly. If it is not inserted, correctly insert the disk so that the label is facing up.
- ▶ Check to see whether the CD/DVD/BD is not dirty. If it is dirty, wipe it with a soft, dry cloth.
- ▶ Check to see whether the CD/DVD/BD is not scratched or bent. If scratched or damaged, replace the CD/DVD/BD.

