

Public Information Display

LCD Display Monitor
User's Guide

DV433

DV503

DV553

DV653

Contents

Important Safety Instructions	2
Installation, Care, and Service	3
Chapter 1: Introduction	6
Safety Icons.....	6
Features of your new LCD Display	7
Package Contents	8
Parts Name and Functions.....	9
Connectors and Terminals.....	11
Infrared Remote Control	13
How to Use the Infrared Remote Control.....	14
Chapter 2: Preparation for use.....	17
Preparation for installation	17
Determine the installation location	17
Ventilation requirements for enclosure mounting	17
Using the wall mount or ceiling mount or handles	19
Installation in portrait or landscape orientation	22
Avoiding Image Retention	23
Connection procedure	24
Connecting with an analog video source	25
Connecting with a digital video source	26
Digital connection:	26
Connecting LAN.....	28
Display connection using LAN.....	28
Connecting the power cord to the display.....	28
Connecting the power source.....	28
Chapter 3: How to use the LCD Display Monitor	30
Turning on all the connected devices.....	30
Power Management Function.....	33
Selecting the video input	34
Select using the SOURCE button on the infrared remote control	34
Select using the SOURCE button on the LCD display	34
Controlling the external devices	34
Selecting the OSD language.....	35
Initial Setting	36

Selecting the picture mode	37
Picture adjustment.....	38
Audio settings.....	39
Treble, bass, and balance adjustment	40
Schedule setting	41
How to set up a schedule.....	42
Viewing media from USB storage	44
Setting up a playlist.....	46
Playing background music	48
Slideshow settings	48
Playing a playlist	49
Remote control.....	52
LAN remote control	55
Configuration and basic operation of the OSD screen	56
Basic operation of OSD screen.....	57
Picture Menu Screen	59
Aspect Ratio Menu Settings	60
Sound Menu Screen.....	61
Setup Menu Screen.....	62
Initial Setting Menu Screen	63
Multi Display Control Menu Screen	64
System Information Menu Screen.....	66
Appendix A.....	67
Specifications	67
LCD Module	67
Viewable Size (H x V)	68
Power Management	68
Power source	68
Power consumption	68
Input/Output Signal	68
AV Input/Output	69
Audio Input/Output.....	69
Dimensions	69
Mass (weight)	70

Dear Customer,

Thank you for purchasing this LCD Display monitor. This manual will help you use the many exciting features of your new LCD Display monitor. **Before operating your LCD Display monitor, please read this manual completely**, and keep it nearby for future reference.

Safety Precautions

WARNING: TO REDUCE THE RISK OF FIRE OR ELECTRIC SHOCK, DO NOT EXPOSE THIS APPLIANCE TO RAIN OR MOISTURE.

	CAUTION: RISK OF ELECTRIC SHOCK DO NOT OPEN	
CAUTION: TO PREVENT ELECTRIC SHOCK, DO NOT REMOVE THE ENCLOSURE. NO USER-SERVICIBLE PARTS INSIDE.		



The lightning flash with arrowhead symbol, within an equilateral triangle, is intended to alert the user to the presence of uninsulated "dangerous voltage" within the product's enclosure that may be of sufficient magnitude to constitute a risk of electric shock to persons.



The exclamation point within an equilateral triangle is intended to alert the user to the presence of important operating and maintenance (servicing) instructions in the literature accompanying the appliance.

WARNING

WARNING: If you decide to wall mount this display, always use a mounting bracket that has been Listed by an independent laboratory (such as UL, CSA, ETL) and is appropriate for the size and weight of this display. The use of inappropriate or non-Listed mounting brackets could result in serious bodily injury and/or property damage

Important Safety Instructions

- 1) **Read these instructions.**
- 2) **Keep these instructions.**
- 3) **Heed all warnings.**
- 4) **Follow all instructions.**
- 5) **Do not use this apparatus near water.**

6) **Clean only with dry cloth.**

7) **Do not block any ventilation openings.** Install in accordance with the manufacturer's instructions.

8) **Do not install near any heat sources** such as radiators, heat registers, stoves, or other apparatus (including amplifiers) that produce heat.

9) **Do not defeat the safety purpose of the polarized or grounding type plug.**

A polarized plug has two blades with one wider than the other. A grounding type plug has two blades and a third grounding prong. The wide blade or the third prong are provided for your safety. If the provided plug does not fit into your outlet, consult an electrician for replacement of the obsolete outlet.



10) **Protect the power cord** from being walked on or pinched, particularly at plugs, convenience receptacles, and the point where they exit from the apparatus.

11) **Only use attachments/accessories specified by the manufacturer.**

12) **Refer all servicing to qualified service personnel.** Servicing is required when the apparatus has been damaged in any way, such as power-supply cord or plug is damaged, liquid has been spilled or objects have fallen into the apparatus, the apparatus has been exposed to rain or moisture, does not operate normally, or has been dropped.

Additional Safety Precautions

13) **CAUTION:** If the monitor is dropped and the cabinet or enclosure surface has been damaged or the monitor does not operate normally, take the following precautions:

- ALWAYS turn off the monitor and unplug the power cord to avoid possible electric shock or fire.
- NEVER allow your body to come in contact with any broken glass or liquid from the damaged monitor. The LCD panel inside the monitor contains glass and a toxic liquid. If the liquid comes in contact with your mouth or eyes, or your skin is cut by broken glass, rinse the affected area thoroughly with water and consult your doctor.
- ALWAYS contact a service technician to inspect the monitor any time it has been damaged or dropped.

14) CAUTION:

- To reduce the risk of electric shock, do not use the polarized plug with an extension cord, receptacle, or other outlet unless the blades can be inserted completely to prevent blade exposure.
- To prevent electric shock, match wide blade of plug to wide slot; fully insert.

15) WARNING:

Do not let children swallow the product or play with the plastic bag. Keep the product and the plastic bag out of the reach of children.

16) CAUTION:

Do not let water or other liquids come into contact with the product, as it may result in damage.

17) WARNING:

- To prevent the spread of fire, keep candles or other open flames away from this product at all times.
- Keep the product away from direct sunlight, fire or a heat source such as a heater. This may reduce the product lifetime or result in fire.

Installation, Care, and Service

Installation

Follow these recommendations and precautions and heed all warnings when installing your LCD Display monitor:

- 18) When operating the LCD display with its AC 220-240V power supply in Europe, use the power supply provided with this display. If a power cord is not supplied with this display, please contact your supplier. This equipment requires an Earthed mains supply connection.
- 19) In the UK, use a BS-approved power cord with molded plug and black (10A) fuse installed.
- 20) When operating the LCD display with a 120V, 60Hz AC power supply in the United States or Canada, use the power cord provided with the display. If a power cord is not supplied with the display, please contact your supplier.
- 21) For all other cases, use a power cord that matches the AC voltage of the power outlet and has been approved by and complies with the safety standards of your particular country.
- 22) Avoid displaying fixed patterns for long periods of time, to avoid image persistence (after image effects).



23) WARNING: NEVER expose batteries to excessive heat such as sunshine, fire or the like.

- 24) ALWAYS plug the product into an outlet that is located in such a manner that it can be easily unplugged in case the product requires service.
- 25) NEVER route the product's power cord inside a wall or similar enclosed area.
- 26) Never modify this equipment. Changes or modifications may void: a) the warranty, and b) the user's authority to operate this equipment under the rules of the Federal Communications Commission.

27)



DANGER: RISK OF SERIOUS PERSONAL INJURY, DEATH, OR EQUIPMENT DAMAGE!

Never place the monitor on an unstable cart, stand, or table. The LCD Display may fall, causing serious personal injury, death, or serious damage to the monitor.



- 28) When selecting a location for the display,
- NEVER allow any part of the display to hang over the edge of supporting furniture.
 - NEVER place the display on tall furniture (for example, entertainment centers or bookcases) without anchoring both the furniture and the display to a suitable support.
 - NEVER allow children to climb on the monitor.
- 29) To avoid damage to this product, never place or store the monitor in direct sunlight; hot, humid areas; or areas subject to excessive dust or vibration.
- 30) The product should not be exposed to dripping or splashing. Objects filled with liquids should not be placed on the apparatus.
- 31) Never block or cover the slots or openings in the monitor cabinet back, bottom, and sides. Never place the monitor:
- On a bed, sofa, rug, or similar surface;
 - Too close to drapes, curtains, or walls; or
 - In a confined space such as a bookcase, built-in cabinet, or any other place with poor ventilation.
- 32) Always leave a space of at least 10cm - 4 (four) inches around the monitor. The slots and openings are provided to protect the monitor from overheating and to help maintain reliable operation of the monitor.

33) Never allow anything to rest on or roll over the power cord, and never place the monitor where the power cord is subject to wear or abuse.

34) Never overload wall outlets and extension cords.

Ergonomics

For maximum ergonomic benefit, we recommend the following:

35) For optimum performance, allow 20 minutes for warm-up.

36) Rest your eyes periodically by focusing on an object at least 5 feet away. Blink often.

37) Use the preset Size and Position controls with standard signals.

38) Use the preset Color Setting.

39) Use non-interlaced signals.

40) Do not use primary color blue on a dark background, as it is difficult to see and may produce eye fatigue due to insufficient contrast.

41) Adjust the display's brightness, contrast, and sharpness controls to enhance readability.



42) Position the display at a 90° angle to windows and other light sources to minimize glare and reflections.

Care

For better performance and safer operation of your LCD Display monitor, follow these recommendations and precautions:

43) Always unplug the monitor before cleaning. Gently wipe the display panel surface (the monitor screen) using a dry, soft cloth (cotton, flannel, etc.). A hard cloth may damage the surface of the panel. Avoid contact with alcohol, thinner, benzene, acidic or alkaline solvent cleaners, abrasive cleaners, or chemical cloths, which may damage the surface. Never spray volatile compounds such as insecticide on the cabinet. Such products may damage or discolor the cabinet.

44) Never hit, press, or place anything on the back cover. These actions will damage internal parts.

45)  **WARNING:** RISK OF ELECTRIC SHOCK 
Never spill liquids or push objects of any kind into the monitor cabinet slots.

46) During a lightning storm, do not touch the connecting cables or product.

47) Always unplug the monitor to completely disconnect from mains power. When the monitor is turned off using the on/off switch, it is not completely disconnected from power and a minute amount of current is still consumed.

48) During normal use, the monitor may make occasional snapping or popping sounds. This is normal, especially when the unit is being turned on or off. If these sounds become frequent or continuous, unplug the power cord and contact a Authorized Service Provider.

49) Handle with care when transporting. Save packaging for transporting. Please clean the ventilation slots on the back of the cabinet to remove dirt and dust at least once a year to maintain reliable operation of the monitor.

50) If using the cooling fan continuously, it's recommended to clean the ventilation slots at least once a month.

51) When installing the remote control batteries;

- Align the batteries according to the (+) and (-) indications inside the case.
- Align the (-) indication of the batteries first inside the case.

Service

52)  **WARNING:** RISK OF ELECTRIC SHOCK 

Never attempt to service the monitor yourself. Opening and removing the covers may expose you to dangerous voltage or other hazards. Failure to follow this WARNING may result in death or serious injury. Refer all servicing not specified in this manual to a Authorized Service Provider.

53) If you have the monitor serviced:

- Ask the service technician to use only replacement parts specified by the manufacturer.
- Upon completion of service, ask the service technician to perform routine safety checks to determine that the monitor is in safe operating condition.

Chapter 1

Introduction

Safety Icons

This manual contains safety instructions that must be observed to avoid potential hazards that could result in personal injuries, damage to your equipment, or loss of data. These safety cautions have been classified according to the seriousness of the risk, and icons highlight these instructions as follows:

▲ DANGER Indicates an imminently hazardous situation which, if not avoided, will result in death or serious injury.

▲ WARNING Indicates a potentially hazardous situation which, if not avoided, could result in death or serious injury.

▲ CAUTION Indicates a potentially hazardous situation which, if not avoided, may result in minor or moderate injury.

CAUTION Indicates a potentially hazardous situation which, if not avoided, may result in property damage.

NOTE Provides important information.

Features of your new LCD Display

True Commercial 16/7 Operation Digital Display

- ❖ **43", 50", 55", and 65"**— These robust displays are specifically designed for long hours of trouble-free operation in a commercial environment, as well as many other commercial features.

Industry LED backlight

- ❖ **LED backlight panel**— Commercial grade panel with a LED backlight. With the LED backlight, the display has achieved low power consumption and eliminated mercury. The slim display design allows installation in various environments than the conventional displays. See page 30.

High-quality LCD panel providing a wide variety of content and messages clearly

- ❖ **Full HD panel**— The LCD display panel reproduce images from video and computer signals with precision and clarity, delivering full 1920 x 1080 high- definition resolution.

Brightness

- ❖ **450 cd/m² 43", 50", 55", 65"**— Creates more compelling, dynamic images to better attract and maintain customer attention in a variety of lighting environments.

Enhanced Display Functionality for Various Applications

- ❖ **Daisy Chain Connection**— By connecting the DVI-D OUT connectors and the DVI-D IN connectors using DVI-D cables (commercially available), you can transmit video signals to up to 9 displays (when using 2-meter cables). This is useful when supplying a video signal to multiple displays.
- ❖ **LAN Control**— You can control multiple displays by sending control commands from a computer via a LAN network. See pages 28.

Others

- ❖ **Built-in Speakers**— This display offers built-in stereo speakers to deliver audio messages. External stereo speakers can also be used. The user can switch between external or built-in speakers from the menu.
- ❖ **Remote Control**— An infrared remote control is supplied to control the various functions of this display, including power on/off, input select, and menu access. See page 13-14.
- ❖ **USB Media Player**— Display and schedule content without an external media player. Built-in USB Media Player CODECs include:
 - **Video:** MPG, MPEG, AVI, MKV, MOV, MP4, TS, M2TS, H.264 (up to level 4.0)
 - **Music:** MP3, WMA, AAC
 - **Photo:** JPG, BMP, PNG (BMPs and JPGs with a resolution larger than 1024x768 may take additional time to display)

8**Chapter 1**
Introduction

Package Contents

Contents		
Item	Unit	Remark
LCD display	1	
Infrared remote control	1	
Batteries	2	AAA size
AC power cable	1	1.8m
3.5mm jack	1	Composite/component conversion cable
Logo cover sheet	1	
User manual	1	
Warranty Sheet	1	Except for EU models
QSG (Quick Setup Guide)	1	For EU models only
Cable Clamps	5	

The supplied power cord varies depending on destination. For the use in the other regions, use a power cord that matches the AC voltage of the power outlet and has been approved by and complies with the safety standard of those regions or countries.

Parts Name and Functions

Buttons and Indicator

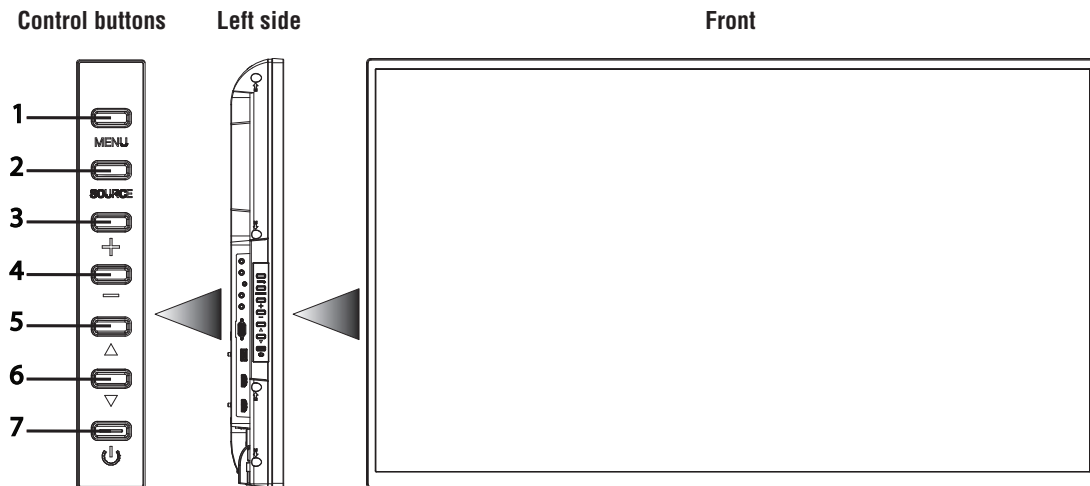

- 1 Menu button**—Enters the On Screen Display (OSD) menu.
- 2 Source button**—Displays the OSD menu to switch the video input. You can select [AV], [COMPONENT], [HDMI1], [HDMI2], [DVI-D], [VGA], and [USB].
- 3 PLUS (+) button**—Increases volume.
- 4 MINUS (-) button**—Decreases volume.
- 5 UP (▲) button**—Moves the highlighted area up in the OSD menu.
- 6 DOWN (▼) button**—Moves the highlighted area down in the OSD menu.
- 7 POWER button**—Switches the power on/off. This button does not work when the power indicator is off. In such cases, turn on the main power switch. (See page 10).

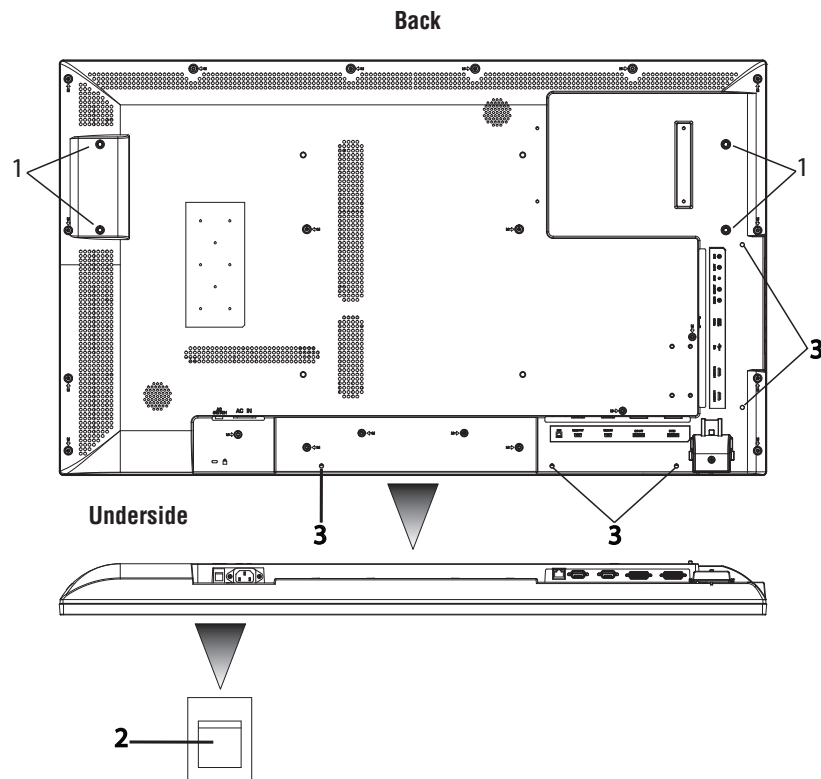

- 1 Handle screw holes** —Used to mount handles (optional), for carrying the LCD display.
- 2 Main Power Switch** —Switches the main power on/off and is used as the disconnect device.
- 3 Cable clamp holes** — Used to clamp cables to the system.

NOTE

Within 2 seconds after turning off the power by the POWER button on the infrared remote control or the display or by a communication command, don't turn off the main power switch, don't disconnect the power cord, and don't turn off the breaker. If the AC power is turned off immediately after the power-off operation, all the OSD settings including the language selection may be reset to the factory defaults at the next power-on. If the OSD settings are reset to the factory defaults as described above, reconfigure the OSD settings using the following procedure.

- Turn off the power of the display using the infrared remote control or another method.
- Wait for at least 2 seconds.
- Turn on the power of the display using the infrared remote control or another method.
- Check and reconfigure the OSD settings.

Connectors and Terminals

For details about using cable types and connections, see pages 24-26.

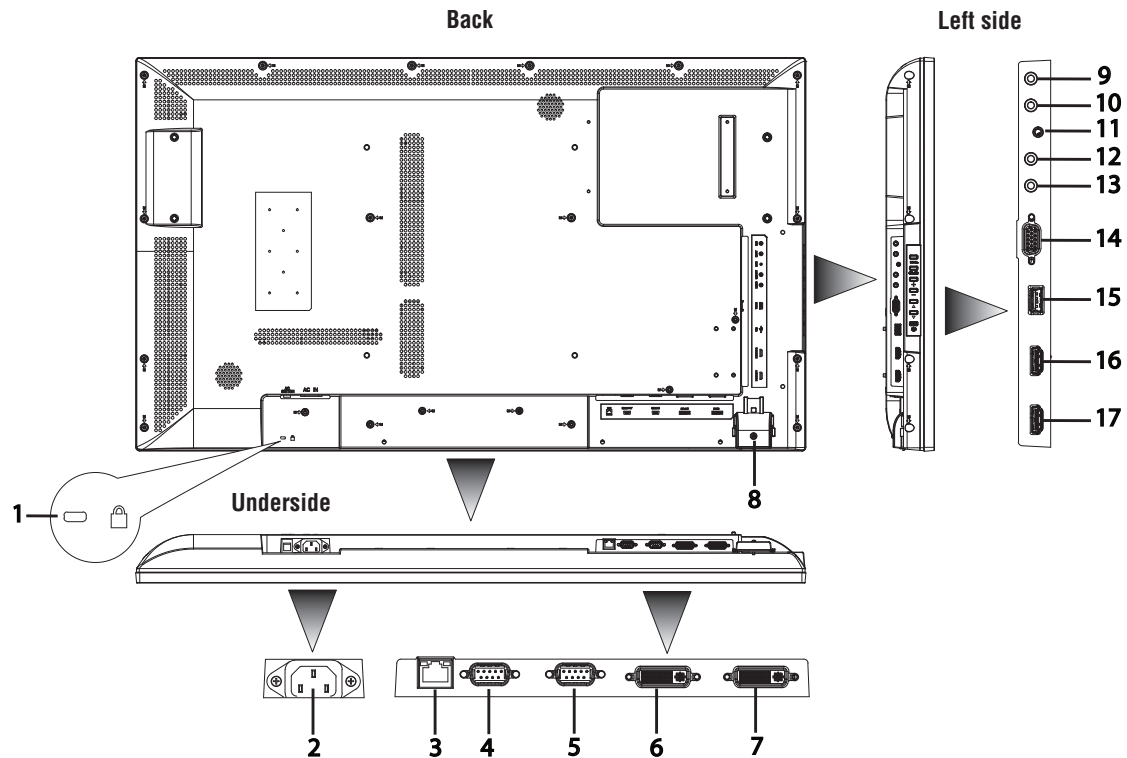

- 1 **ANTI-THEFT LOCK**—Used to attach a commercially available antitheft device.
- 2 **AC IN (3-pin, with earth terminal)**—Connects with the supplied power cord. Class I Product requires an earthed mains supply connection.
- 3 **LAN (RJ45 ETHERNET)**—Connects with an Ethernet cable for LAN access.
- 4 **RS-232C OUT**—Connects with the RS-232C IN connector of other connected LCD display monitor.
- 5 **RS-232C IN**—Connects with the RS-232C OUT connector of a computer or other connected LCD display monitor.
- 6 **DVI-D OUT**—Outputs the signal that is supplied to the DVI-D IN connector (7).
- 7 **DVI-D IN**—Connects with the digital video output of a computer, etc.
- 8 **REMOTE CONTROL SENSOR AND POWER INDICATOR**— Remote control sensor: Receives the signal from the infrared remote control. Power indicator: Indicates the state of the LCD display.
- 9 **IR IN**—Connects with the IR output of an IR control.
- 10 **IR OUT**—Outputs the signal that is supplied to the IR IN connector (9).
- 11 **AV (Analog Video In)**—Use the supplied cable in the package to connect with the video output connector of external equipment such as a computer, VCR, and DVD player., etc. This connector supports component video (YPbPr) and analog video (AV) input.
- 12 **LINE OUT**— Outputs the signal that is supplied to the LINE IN connector (13). Connects with an external audio amplifier, etc. Headphones and earphones are not supported.

12

Chapter 1 *Introduction*

- 13 LINE IN**—Connects with the audio visual output connector of external equipment such as a computer, VCR, and DVD player
- 14 VGA IN**—Connects with the analog video output of a computer.
- 15 USB PORT**—USB port for portable media (USB drive, etc).
- 16 HDMI2**—Connects to devices supporting audio/video signals with HDMI interface.
- 17 HDMI1**—Connects to devices supporting audio/video signals with HDMI interface.

Infrared Remote Control

- 1 POWER button**—Switches the power on/off. When the Power indicator is not glowing red, no controls will work.
- 2 SOUND buttons**—You can select [STANDARD], [DYNAMIC] and [CUSTOM].
- 3 PICTURE button**—Selects the picture mode from [DYNAMIC], [ADVERTISER], [CUSTOM], and [STANDARD].
- 4 INFO button**—Displays the current screen resolution and refresh rate.
- 5 VOLUME buttons (VOL)**—Pressing the plus (+) side increases the audio output level. Pressing the minus (-) side decreases the audio output level.
- 6 MUTE button**—Switches the mute function on/off.
- 7 UP/DOWN/RIGHT/LEFT buttons**—Moves the currently highlighted area in the OSD menu. (▲) button moves the highlighted area up, (▼) moves the highlighted area down, (◀) moves the highlighted area left, (▶) moves the highlighted area right.
- 8 MENU button**—Switches the OSD menu mode on/ off.
- 9 MEDIA CONTROL buttons**—Contextual buttons providing various media control functions in specific menus. Each button's functions will be shown in the OSD in corresponding colors.
- 10 INPUT button**—Displays the OSD menu to switch the video input. You can select [AV], [COMPONENT], [HDMI1], [HDMI2], [DVI-D], [VGA], and [USB].
- 11 ASPECT button**—Displays the current display aspect ratio.
- 12 INPUT button**—Displays the OSD menu to switch the video input. You can select [AV], [COMPONENT], [HDMI1], [HDMI2], [DVI-D], [VGA], and [USB].
- 13 OK button**—Accepts the settings made in the OSD menu.
- 14 BACK button**—Displays the previous OSD menu.
- 15 AUDIO/VIDEO CONTROL buttons**—Provide control functions when playing media files. Fast reverse (◀◀), play (▶), fast forward (▶▶), track backwards (◀◀), stop (■), pause (⏸), and track forward (▶▶).

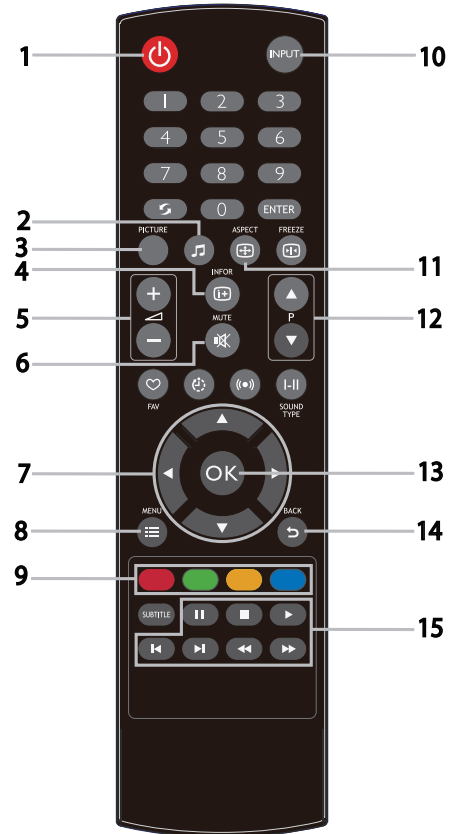

How to Use the Infrared Remote Control

Setting Up the Infrared Remote Control Sensor

Before using the infrared remote control, the LCD display's remote control sensor must be positioned. The remote control sensor is a small black box located on the back of left of the LCD display. Press the small button near the base of the remote control sensor, and slide the sensor away from the LCD display until it locks in place. Reverse this procedure to return the sensor to its original position.

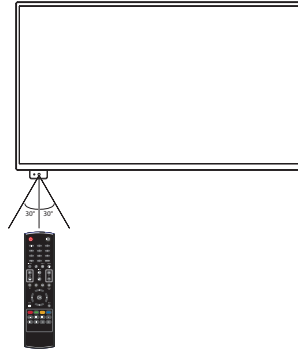

Operating Range of the Infrared Remote Control

Point the infrared remote control toward the LCD display's remote control sensor during button operation. Use the infrared remote control within a distance of about 10 m from the front of the LCD display's remote control sensor and at a horizontal and vertical angle of within 30° within a distance of about 10 m.

NOTE

The remote control system may not function when direct sunlight or strong illumination strikes the remote control sensor of the LCD display, or when there is an object in the path.

Handling the infrared remote control

- Do not subject to a strong shock.
- Do not allow water or other liquid to splash on the infrared remote control. If the infrared remote control gets wet, wipe it dry immediately.
- Avoid exposure to heat and steam.
- Other than to install the batteries, do not open the infrared remote control.

Installing and removing the infrared remote control batteries

The infrared remote control is powered by two 1.5 V AAA batteries.

How to install the batteries

- 1 Unlock and pull up the cover.

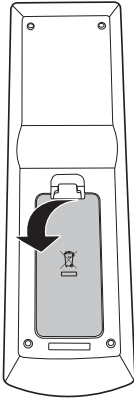

- 2 Align the batteries according to the (+) and (-) indications inside the case.

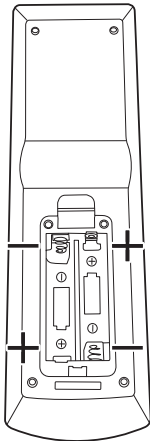

- 3 Replace the cover.

How to remove the batteries

- 1 Unlock and pull up the cover.
 - 2 Remove the batteries.
-

⚠ CAUTION

Incorrect use of batteries can result in leaks or explosion. Be especially careful of the following points.

- Place “AAA” batteries matching the (+) and (-).
 - Do not mix battery types.
 - Do not combine new batteries with used ones.
 - Remove dead batteries immediately to prevent battery leakage
 - Do not touch exposed battery acid, because it will cause damage to your skin.
-

NOTE

- When the remote control no longer works at all, replace both batteries with new ones.
 - If you do not use the remote control for a long time, replace both batteries with new ones.
-

Chapter 2

Preparation for use

Preparation for installation

Determine the installation location

CAUTION

DO NOT ATTEMPT TO INSTALL THE LCD DISPLAY BY YOURSELF.

Installing your LCD display must be done by a qualified technician. Contact your dealer for more information.

NOTE

Proper operation of the display is not guaranteed when it is mounted upside down or face down.

CAUTION

Lay the protective sheet, which was wrapped around the LCD display when it was packaged, beneath the LCD display so as not to scratch the panel.

NOTE

The LCD display requirements apply for equipment operating up to 2,000m above sea level.

Ventilation requirements for enclosure mounting

To allow heat to disperse, leave space around the display.

NOTE

Don't block the vents in the back of the display shown in the figure on the next page. If they are blocked, heat accumulates inside the display, and can cause breakdown. The upper limit of the operation guaranteed ambient temperature when the display is installed in the landscape position is 40°C (104°F). When installing the monitor in a case or an enclosure, ensure adequate ventilation to keep the temperature inside the case is be 40°C (104°F) or below by providing a cooling fan or ventilation holes in the case.

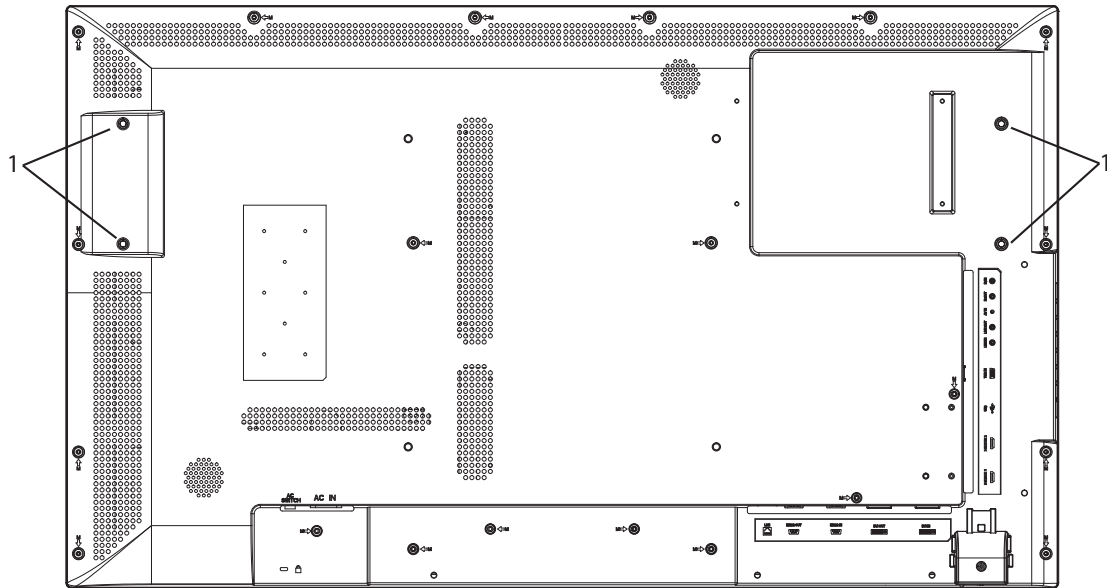

Don't block the ventilation vents (1) Screw holes for handles

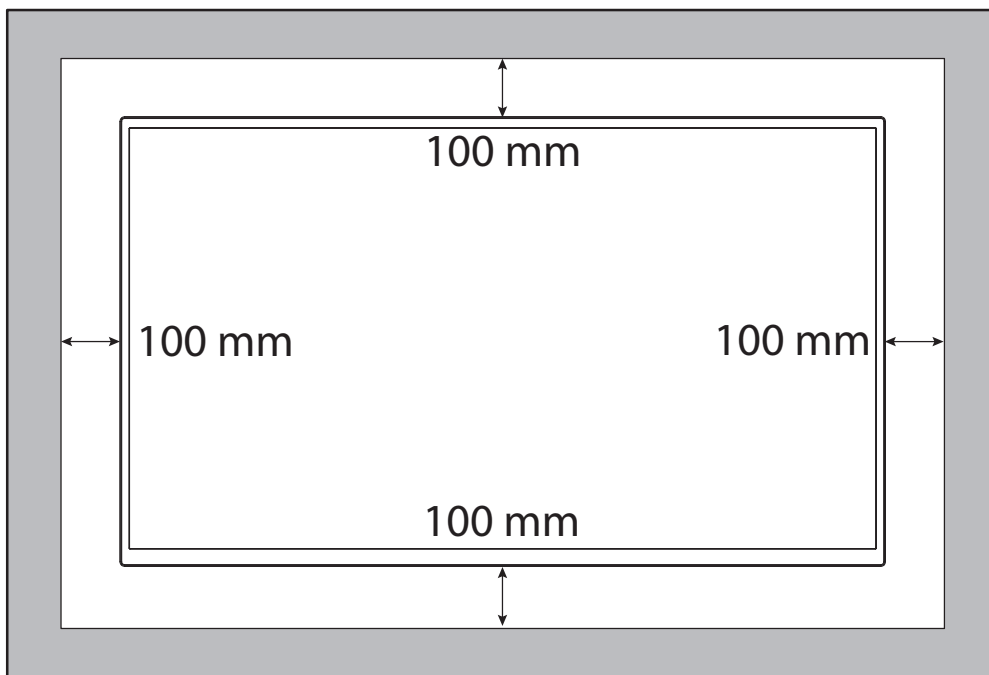

Using the wall mount or ceiling mount or handles

Lay the screen face down

Lay the protective sheet on a table, which was wrapped around the display when it was packaged, beneath the screen surface so as not to scratch the screen surface.

This device cannot be used or installed without a mounting accessory. Failure to follow the correct mounting procedures can result in damage to the product caused by improper installation. Failure to follow these recommendations can void your warranty.

For installation, use M6 screws (with a Boss screw thread of at least 15mm, a loose-proof spring washer, and a length 10 mm longer than the thickness of the mounting bracket), and tighten them securely.

Secure handles (optional parts), using M6 screws with a length less than the thickness of the handle plus the allowable depth of the screw holes (5mm for the 43" display, 9mm for the 50"/55" displays, and 6mm for the 65" display).

We recommend using a mounting interface that complies with VESA Requirements, TUV-GS or for North America UL1678.

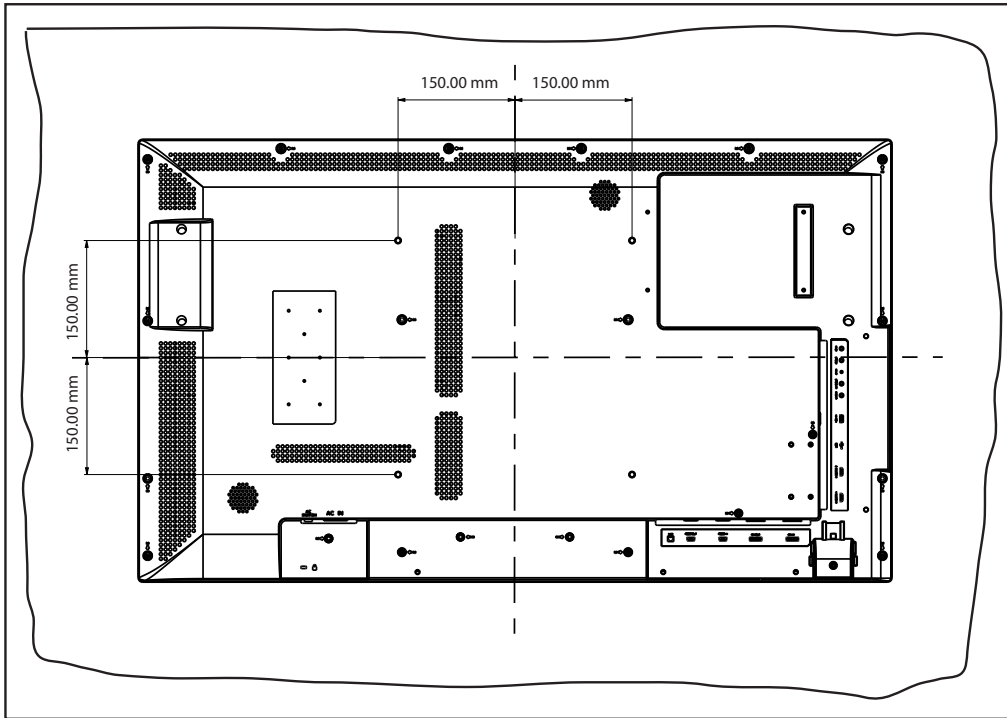

43''

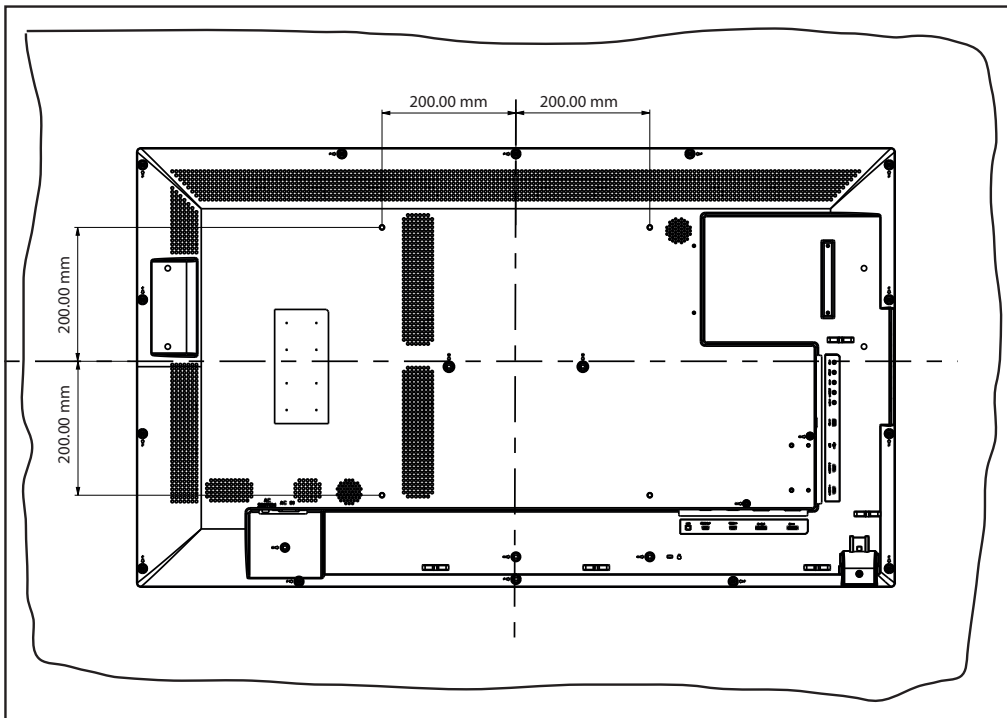

50''/55''/65''

▲ CAUTION

To prevent the display from falling:

- Install the display with metal brackets for wall or ceiling installation (commercially available) in your own responsibility. For detailed procedures of installation, refer to the instructions of the metal brackets.
 - To reduce the probability of injury and damage, be sure to consult the bracket manufacturer for installation location.
 - To reduce the risk of falling in case of unexpected shocks, earthquakes or other disasters, attach a rope to the left of the display and secure the rope to the wall display.
 - The display may topple over or fall in case of earthquake or other disaster.
 - Use stainless steel screws with enough strength to support the LCD display.
 - With regard to the metal bracket:
 - Use a VESA-compliant metal bracket (commercially available) that is strong enough to hold the display.
 - When using a bracket, do not block the heat dissipating holes in the display. See pages 17-18.
 - Before installation, make sure that the installation surface has sufficient strength.
 - For details of the mounting procedure and the safe installation procedure, see the user instructions of the metal bracket (commercially available) to be used.
 - Take measures such as using multiple metal brackets, holding the display at several points, and taking measures to prevent falling or dropping in case of a problem.
-

Installation in portrait or landscape orientation

The display can be installed in portrait or landscape orientation. Ensure that the display is oriented as shown in the images in this section.

NOTE

- The operating environmental condition (temperature) when the display is in portrait orientation is 0°C to 40°C (32° to 104°F).
- Proper operation of the display is not guaranteed when it is not mounted as shown below (upside down, face down, etc.).
- In portrait or face-up orientation, the lifetime of the backlight is shorter than when in landscape orientation.

Installation in the portrait position

The buttons should be on the bottom side when viewed from the front of the display.

This display doesn't have a function to rotate displayed images. To display images in the portrait orientation, use already rotated images

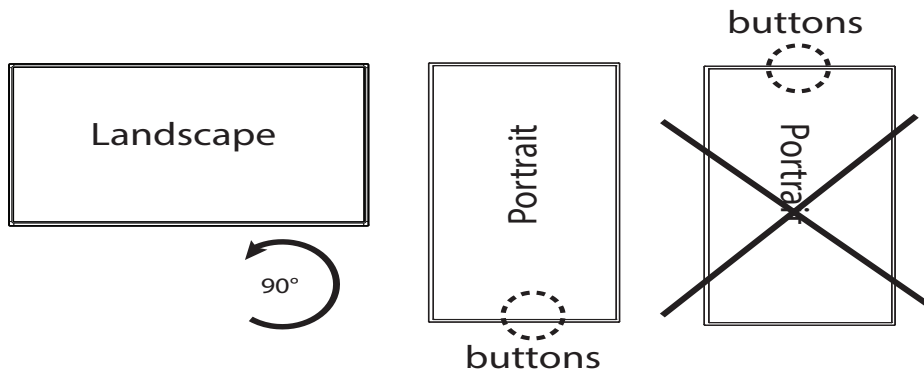

Installing in the face-up position. Do not install in the face-down position.

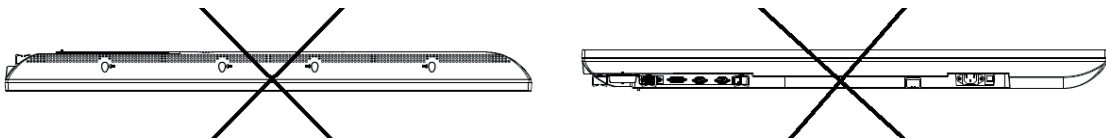

Operation environment for portrait and face down (between 0° and 15°) installation

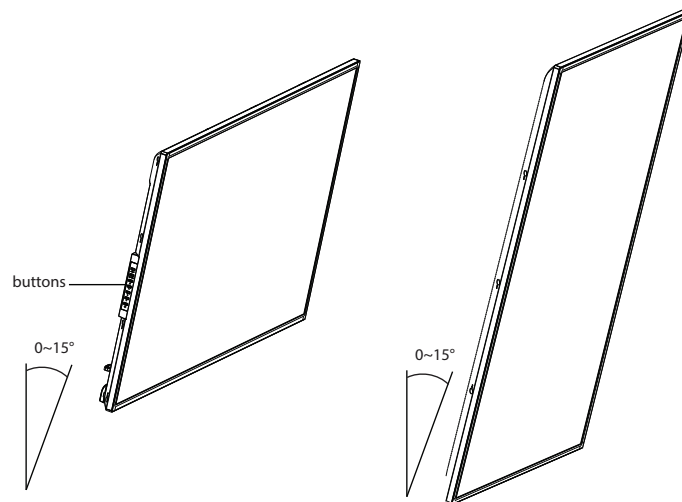

The following operation environment details apply when the display is installed in portrait and face up orientations.

- Temperature 0 - 40°C / 32 - 104°F
- Humidity 20 - 80% (without condensation)

Power connection instructions

- 1 Confirm Main Switch is off before making any connections.
- 2 Use an AC socket located near the display.

Avoiding Image Retention

CAUTION

Do not display static (non-moving) content on the display for long periods of time. This may cause image “burn-in” or image retention, which is not covered under warranty.

Avoid Static Content

- Display dynamic (moving) images whenever possible.
- Turn off the display when not in use, or use the scheduling feature to turn the display off automatically at pre-set times of the day.

Connection procedure

Before making connections:

- First turn off the power of all the connected equipment before making connections.
 - Refer to the user manual of each piece of equipment.
-

NOTE

Please use a low resistance audio cable when the audio output terminal of the audio device and PC is a stereo mini-jack. High resistance audio cables may affect audio levels, or mute sound completely.

Connecting with an analog video source

Analog connection:

- 1 Connect a signal cable (VGA or YPbPr cable), to the VGA or AV IN connector.
- 2 Select AV, Component, or VGA using the SOURCE button on the LCD display, or the SOURCE button on the infrared remote control. Once selected, the audio automatically switches to [LINE IN].

Audio connection:

- Connect an audio cable (ø3.5-mm stereo mini) (commercially available), to the LINE IN connector. Because the audio automatically switches to [LINE IN], the audio is output simply by connecting the cable.

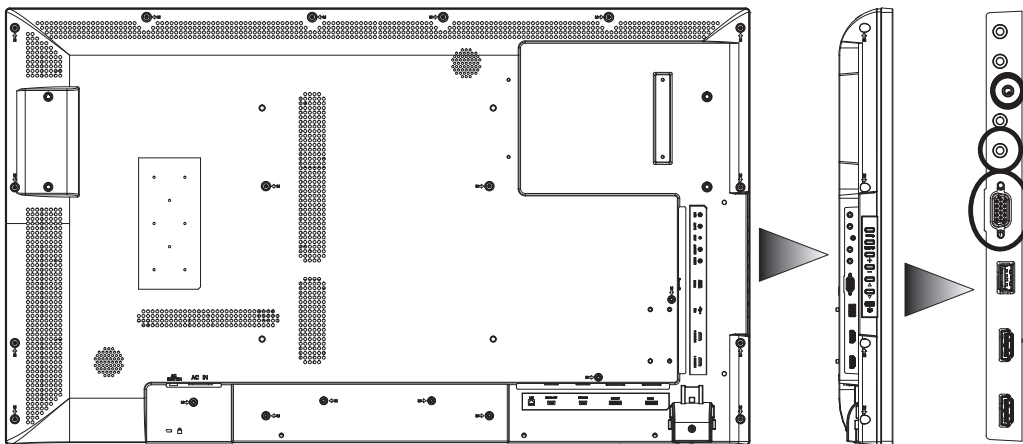

The display automatically distinguishes the timings shown in the table below, and sets the screen information. When a PC or other device is connected, it automatically displays images properly. See ““Connecting with a digital video source”” on page 26.

Connecting with a digital video source

Digital connection:

- **Connection via the HDMI IN connector**

- (1) Connect an HDMI cable (commercially available) to the HDMI1 IN or HDMI2 IN connector.
- (2) Select [HDMI1] or [HDMI2] according to the connected connector by pressing the SOURCE button on the LCD display or the HDMI1 or HDMI2 button on the infrared remote control.

- **Connection via the DVI-D IN connector**

- (1) Connect a DVI-D cable (commercially available) to the DVI-D IN connector.
- (2) Select [DVI-D] using the SOURCE button on the LCD display or the DVI-D button on the infrared remote control.

Second display connection:

- Connect the DVI-D OUT connector on the first display and the DVI-D IN connector on the second display using a DVI-D cable (commercially available).

NOTE

- **The daisy chain connection allows up to 9 LCD displays to be connected (when using 2-meter cables. However, the maximum number of connectable LCD displays may be limited. It is recommended to check the number of connectable LCD displays in your installation environment in advance.**
 - **Set the power off time using the POWER SAVE selection in the SETUP menu.**
 - **Tiling mode can be used in HDMI1/2 for multi displays, if there is an external HDMI splitter equipped.**
-

Audio connection:

- For HDMI 1/2/DVI-D, the default setting of audio source is a TMDS signal with HDMI/ DVI cable. Users can use an external audio source if an audio cable (ø3.5-mm stereo mini) (commercially available) is connected to the LINE IN connector. LINE IN” should be selected for the audio input source.
- To output the audio to the second display, connect the LINE OUT connector on the first display and LINE IN connector on the second display using an audio cable (ø3.5-mm stereo mini) (commercially available).

NOTE In this image the dashed lines around ports indicate connections OUT, and the small screen at front indicates the second display.

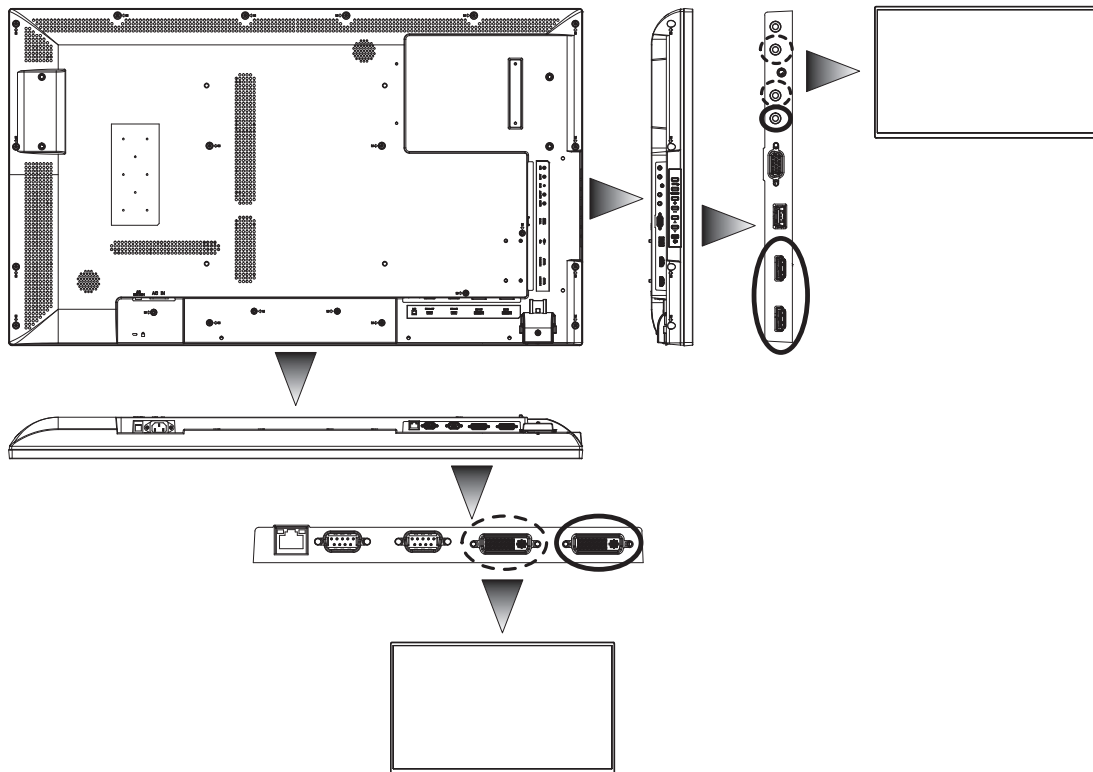

Connecting LAN

Display connection using LAN

As shown in the illustration below, you can connect this display and a computer in network through a LAN hub. Connect the display and the LAN hub using a straight type LAN cable (commercially available).

How to connect

- Turn off the main power switch of the computer and this display. If you make a connection while the power is on, it the devices may fail.
- Connect the computer and the LAN hub using a straight type LAN cable (commercially available).
- Connect this display and the LAN hub using a straight type LAN cable (commercially available).
- When you connect two or more displays, you can connect the display and the LAN hub using a straight type LAN cable (commercially available) as described above.

NOTE

- When you use a cross type LAN cable (commercially available), you can connect the display and the computer one-to-one without using a LAN hub, however, the computer may not be supported. It is recommended to check the operation in advance.
 - If “LAN” control is selected, set “Standby Mode” to “Normal”; the power-on function with LAN control will not work when Standby Mode is ECO.
-

Connecting the power cord to the display

Connecting the power source

Before making connections

- 1 Check that the main power switch is off.

NOTE

Please refer to “Important Safety Instructions” and “Installation, Ergonomics, Care, and Service” in this manual for proper selection of the AC power cord. Use the clasper to prevent accidental disconnection of the power cord.

- 2 Insert the power plug into the power outlet socket.
 - Fully insert the prongs into the power outlet socket. Loose connections may cause noise.
 - Don't plug and unplug the power cord repeatedly in a short period of time.

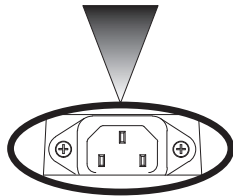
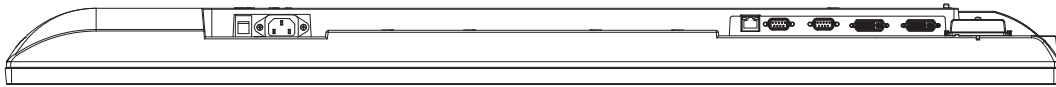
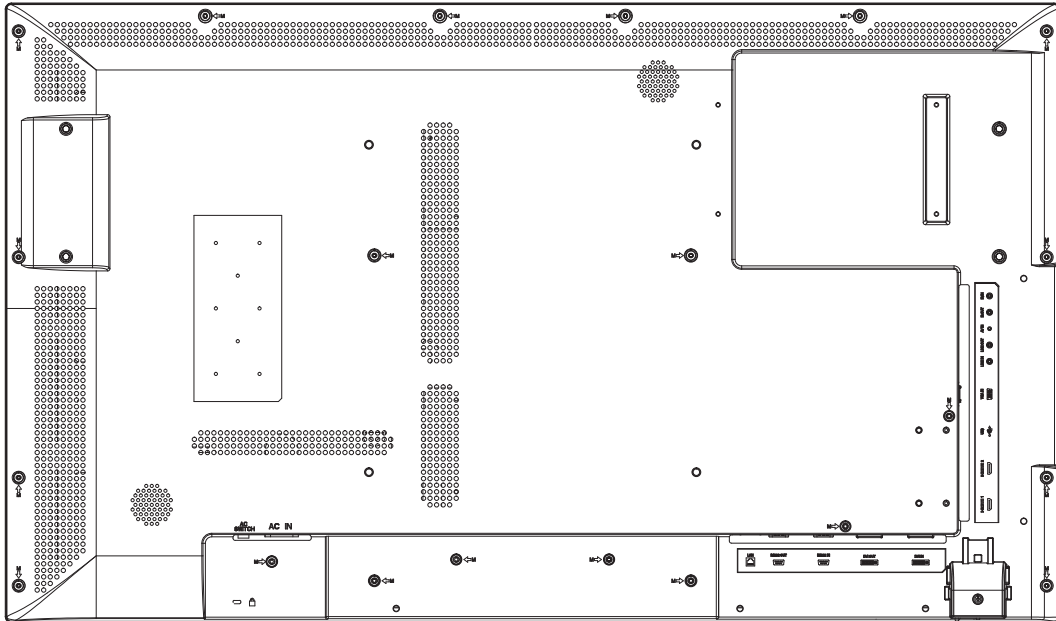

Chapter 3

How to use the LCD Display Monitor

Turning on all the connected devices

- 1 Turn on all connected devices, such as a computer and DVD player.
- 2 Set Up the Infrared Remote Control Sensor

Before using the infrared remote control, the LCD display's remote control sensor must be positioned. The remote control sensor is a small black box located on the back of left of the LCD display. Slide the sensor away from the LCD display until it locks in place (see bottom right in the image below). Reverse this procedure to return the sensor to its original position.

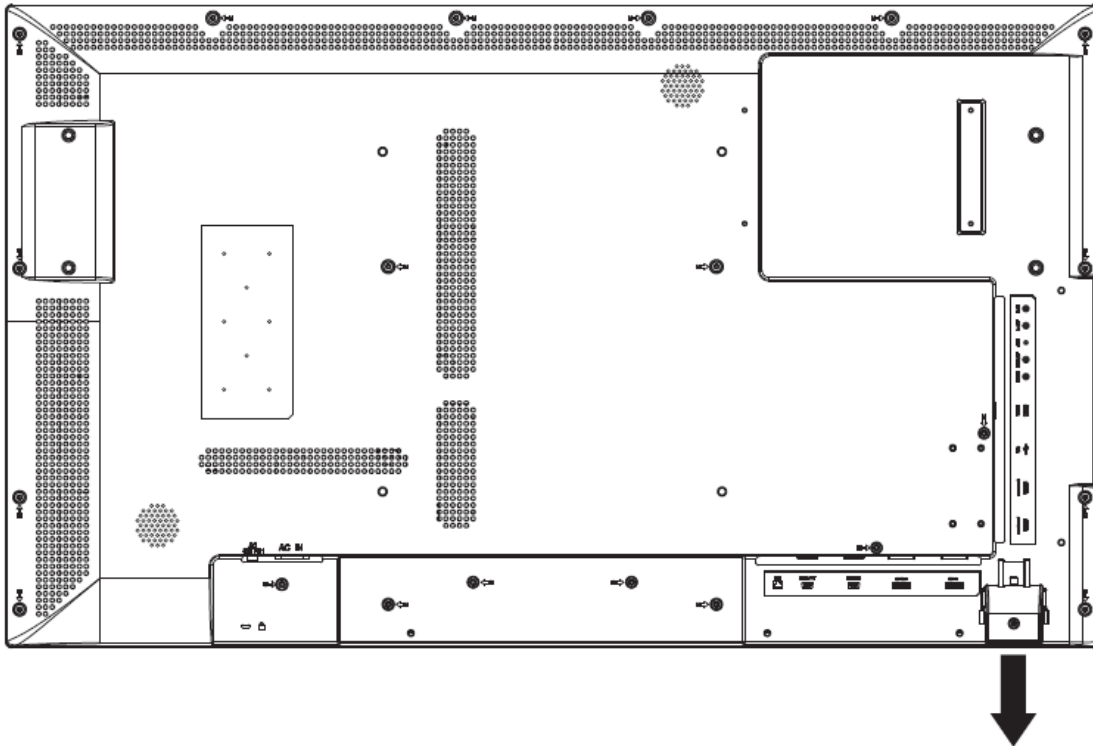

3 Turn on the Main Power Switch.

The power indicator turns on green and the display turns on. The control buttons on the back, infrared remote control, and schedule setting do not work while then main power switch is off (the power indicator is off). When using them, check that the Main Power Switch is on (the power indicator is on).

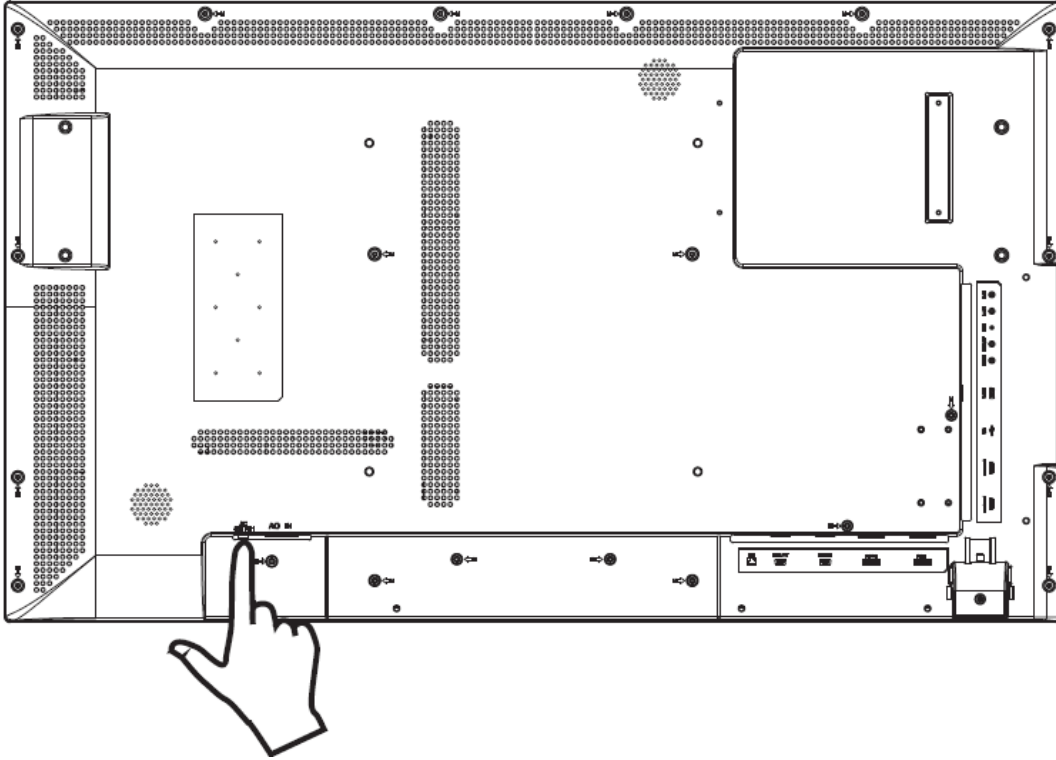

Main power switch

(sample illustration) 43" power switch

4 Turn on the LCD Display.

Press the POWER button on the left side of the LCD display, or the POWER button on the top left of the infrared remote control.

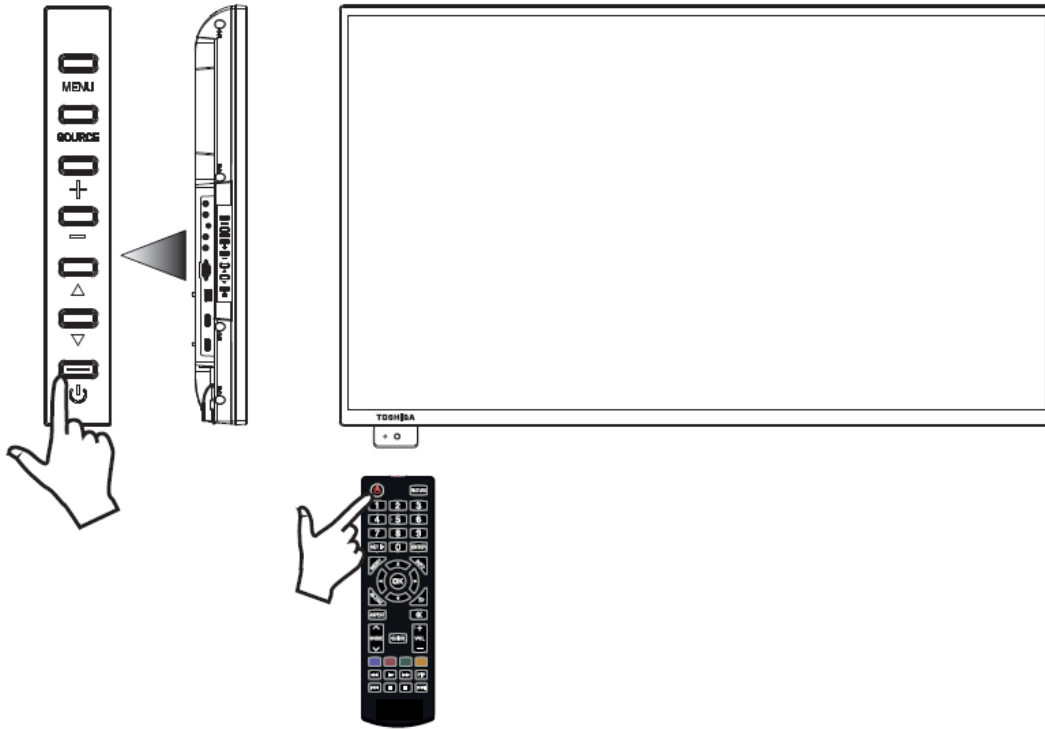

NOTE

Within two seconds of turning off the power using the POWER button on the infrared remote control or the display or by a communication command, don't turn off the main power switch, don't disconnect the power cord, and don't turn off the breaker. If the AC power is turned off immediately after the power-off operation, all the OSD settings including the language selection may be reset to the factory defaults at the next power-on. If the OSD settings are reset to the factory defaults as described above, reconfigure the OSD settings using the following procedure.

- Turn off the power of the display using the infrared remote control or another method.
- Wait for at least 2 seconds.
- Turn on the power of the display using the infrared remote control or another method.
- Check and reconfigure the OSD settings.

Power Management Function

To reduce power, the display supports three power off methods, for different purposes.

- Sleep Timer
 - The user can set the timer to power off the display, regardless of the current source signal status. Sleep timer options are 5 mins, 15 mins, 30 mins, 60 mins, 90 mins, 120 mins, 180 mins, and off, in OSD menu.
 - This value will not be saved. It only executes once, and the default is OFF.
- Power Saving Timer
 - This timer will power off the display when the current source has no signal. The power saving timer adjustable range is 30 sec-300 sec, or off. This timer can be disabled in the OSD menu.
 - This value will be saved; the default is 300 sec.
 - If the LCD display switches to standby mode as a result of the Power Saving Timer of a VGA or HDMI source (but not DVI-D), the display will power on automatically if the signal from the current source returns.

NOTE Not all video devices are guaranteed to support the auto power on function when connected to the LCD display.

- Schedule
 - The user can set seven schedules to determine power on times and power off times. Detailed settings refer to the schedule function.

The display also has a priority mode.

- Schedule setting priority is higher than sleep timer and power saving timer.
- Sleep timer priority is the same as power saving timer; if both timers are enabled, the display power off time will depend on the power saving timer or if the sleep timer is up.

Power Indicator	
Status	LED
Power-on mode	Green
Power-off mode	Red
Power Standby when "SCHEDULE" is enabled	Amber
Main power is off	Off
Diagnosis (detecting failure)	Red Blinking *Please contact your nearest authorized service facility.

Selecting the video input

Select using the SOURCE button on the infrared remote control



You can select the desired video input by pressing the SOURCE button on the infrared remote control, and using the UP (▲) and DOWN (▼) buttons to make your selection. Selectable video inputs are [AV], [COMPONENT], [HDMI1], [HDMI2], [DVI-D], [VGA], and [USB].

Select using the SOURCE button on the LCD display

When you press the SOURCE button on the LCD display, the video input OSD menu is displayed and you can select the video input using the UP (▲) and DOWN (▼) buttons.

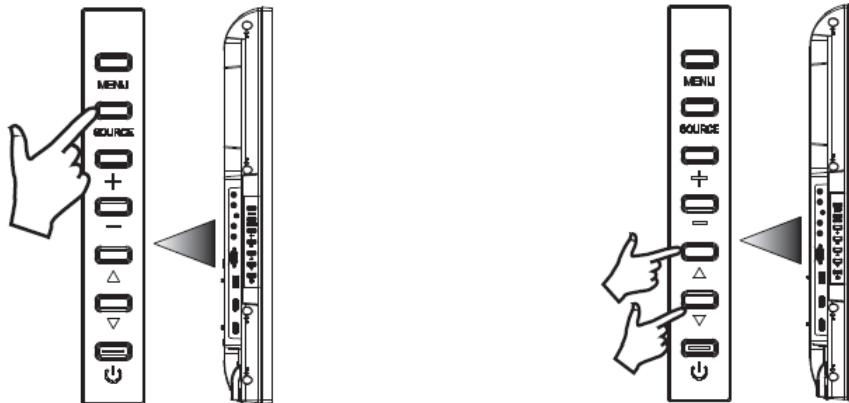

Selectable video inputs are [AV], [COMPONENT], [HDMI1], [HDMI2], [DVI-D], [VGA], and [USB]. When you press the SOURCE button again, the selected video input is displayed.

The selection you make is input automatically after several seconds.

Controlling the external devices

To control the connected external devices, display images on the LCD display.

Selecting the OSD language

Display the OSD menu by pressing the MENU button on the infrared remote control, or the MENU button on the left side of the LCD display.

Using MENU LANGUAGE in the INITIAL SETTINGS menu of the OSD screen function, you can select the OSD language.

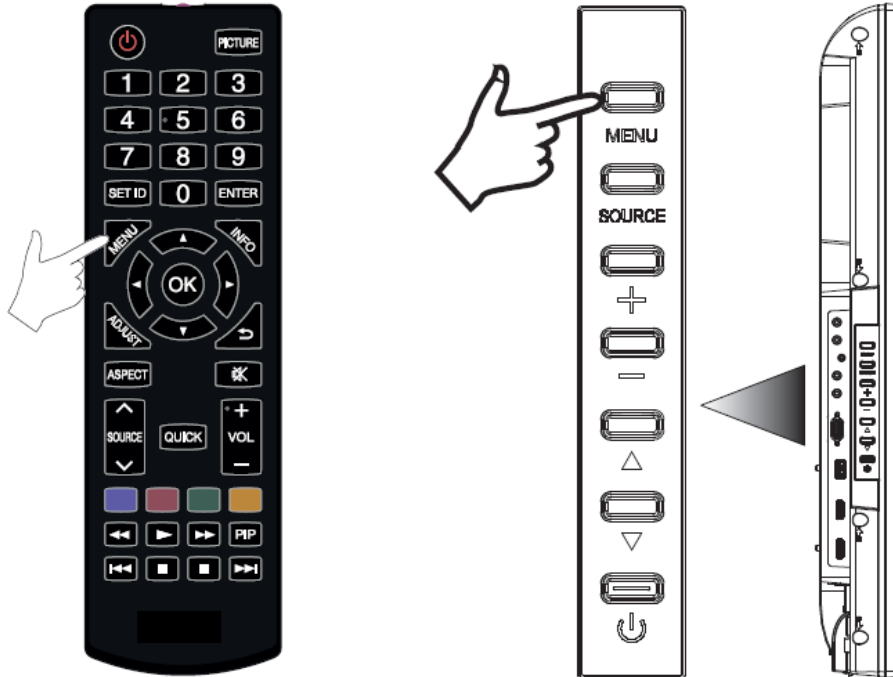

Initial Setting

- 1 Press the MENU button on the infrared remote control to directly display the OSD menu function.
- 2 Use the DOWN (▼) button on the infrared remote control or the DOWN (▼) button on the left side of the LCD display, to select INITIAL SETTING.
- 3 Press the [OK] button on the infrared remote control, or the MENU button on the left side of the LCD display to enter the INITIAL SETTING menu.

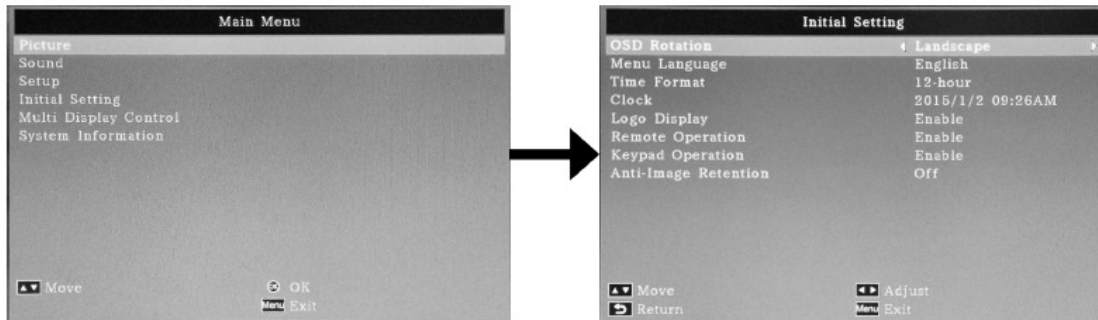

Initial Settings	
Setting	Details
OSD Rotation	Select the OSD orientation.
Menu Language	Select the menu language.
Time Format	Set the time format.
Clock	Set the clock time.
Logo Display	Logo display option (enable/disable).
Remote Operation	Remote control option (enable/disable). <i>Note: If Remote operation is disabled, you can press "menu", "left", "right", "up", "down" to enable the function.</i>
Keypad Operation	Keypad control option (enable/disable).
Anti-Image Retention	Anti-image retention options.

Selecting the picture mode

Using the PICTURE button on the infrared remote control, you can select the picture mode suitable for images to be displayed.

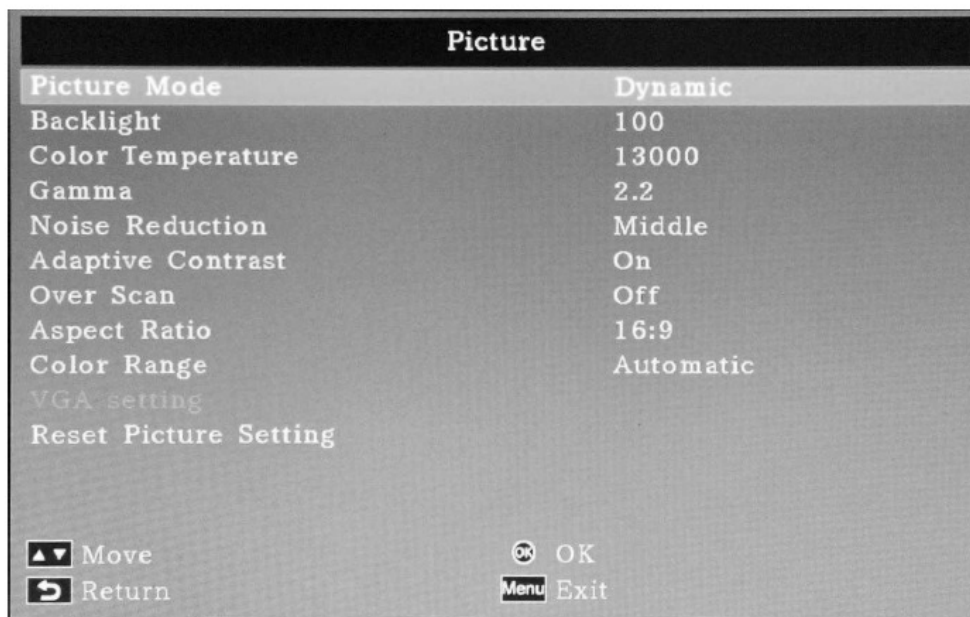

Picture Mode	
Setting	Details
DYNAMIC	Maximum brightness.
ADVERISERT	Suitable for Adverisert
CUSTOM	Use previously saved custom picture settings (by default this mode uses the STANDARD settings). Set up through the OSD once in CUSTOM picture mode.
STANDARD	Factory default setting.

- "ADVERISERT" can be selected for video input (HDMI1*, HDMI2*, YPbPr, VIDEO, and S-VIDEO).
- *Automatically selected depending on the input signal.

Picture adjustment

Display the OSD menu by pressing the MENU button on the infrared remote control, or the MENU button on the left side of the LCD display. Using the PICTURE menu of the OSD screen function, you can adjust picture settings such as brightness, contrast, and sharpness, to obtain the desired image quality.

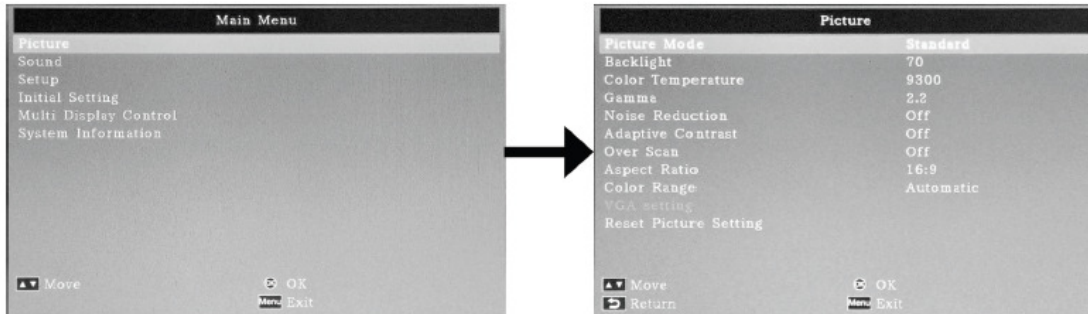

Picture Adjustment	
Setting	Details
Contrast	0-100
Brightness	0-100
Sharpness	0-10
Color temperature	4900K, 6500K, 9300K, 11500K and CUSTOM

Audio settings

Select the built-in speakers or the external stereo speakers in the speaker setting in the OSD menu. Display the OSD menu by pressing the MENU button on the infrared remote control, or the MENU button on the left side of the LCD display. Using SPEAKER in the SOUND menu of the OSD screen function, you can select the speakers. Using AUDIO SOURCE in the SOUND menu, you can select which source to use for audio input. This setting will display all available audio sources (LINE IN, HDMI2, etc); an audio source must be connected to the LCD display to be available.

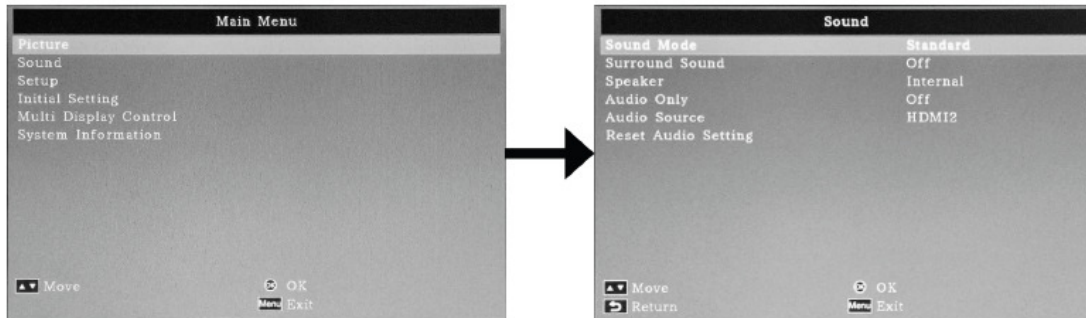

Audio Settings	
Setting	Details
Sound Mode	Set sound mode settings.
Surround Sound	Turn surround sound on or off.
Speaker	Select speaker (internal/external),
Audio Only	Output audio without video (on/off).
Audio Source	Select audio source.
Reset Audio Setting	Reset to factory default settings.

Treble, bass, and balance adjustment

You can adjust the speaker treble, bass, and balance, using the SOUND menu on the OSD screen function. For adjustment, display the OSD menu by pressing the MENU button on the infrared remote control or the MENU button on the left side of the LCD display. Using SOUND STYLE in the SOUND menu, you can select or edit sound styles. There are three selections; STANDARD (default factory settings), DYNAMIC (settings for enhanced sound), and CUSTOM (uses previously saved custom sound settings). By default, the CUSTOM mode uses the STANDARD settings.

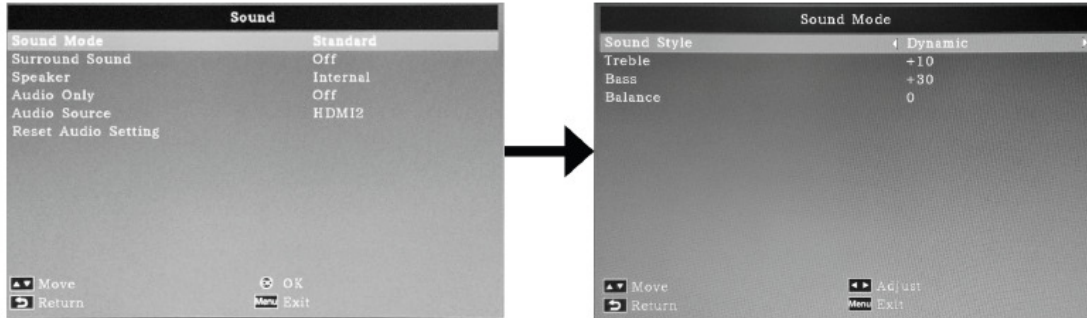

Treble, Bass, and Balance Adjustment	
Setting	Details
Sound Style	Select or edit sound style.
Treble	Adjust treble settings.
Bass	Adjust bass settings.
Balance	Adjust balance settings.

Schedule setting



You can program power-on/off and input selection using the QUICK button on the infrared remote control, which enters the SCHEDULER settings in the OSD menu. Alternatively, display the OSD menu by pressing the MENU button on the infrared remote control or the MENU button on the left side of the LCD display. Using SCHEDULER in the SETUP menu of the OSD screen function, you can program power-on/off and input selection.

How to set up a schedule

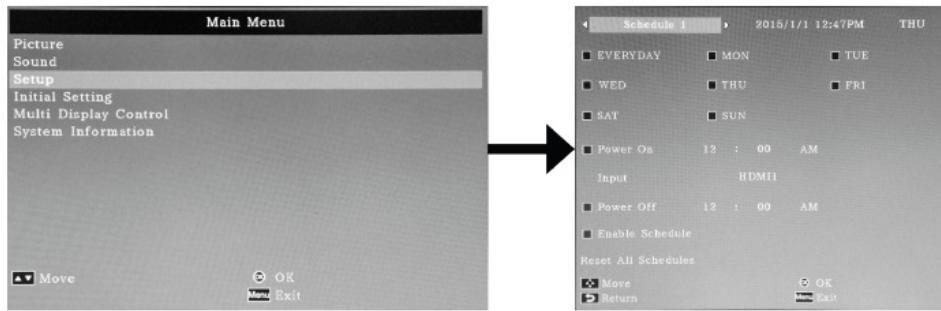

Program number selection

When the cursor is in any of the check boxes showing the program numbers 1 to 7 on the left side of the screen, press the UP (▲) and DOWN (▼) buttons to move the cursor up or down to select the program number you want to set.

To enable the selected program number, press the SET button to place a checkmark in the check box. To disable it, clear the checkmark.

Schedule setting of each program

When the cursor is in any of the check boxes, pressing the PLUS (+) button moves the cursor into the white frame on the right.

When the cursor is at any of the items within the white frame, pressing the PLUS (+) button moves the cursor to the right, and MINUS (-) button to the left.

You can set the power-on/off time and video input by pressing the UP (▲) and DOWN (▼) buttons. In addition, you can select or deselect the radio buttons by pressing the SET button.

Schedule Setting	
Setting	Details
SCHEDULE 1	Select and program up to seven schedules.
EVERY DAY	Select this option to execute the schedule every day. When you select EVERY DAY, you cannot select both individual days of the week and EVERY WEEK.
MON-SUN	Select the days of the week on which you want to execute the schedule. Unless you also select EVERY WEEK, the selection of the days of the week is cleared after the schedule is executed one time.
SOURCE	Select the preferred audio-video input source.
POWER ON	Set the time when the power is turned on. If you don't want to set the power-on schedule, do not check the power on item.
POWER OFF	Set the time when the power is turned off. If you don't want to set the power-off schedule, do not check the power off item.
ENABLE SCHEDULE	Enable/disable the current schedule.
RESET ALL SCHEDULES?	Reset all schedules to factory defaults (no scheduling).

Schedule confirmation

To confirm the schedule, select ENABLE SCHEDULE in the OSD, then press the MENU button on the infrared remote control or the MENU button on the left side of the LCD display to exit the SCHEDULE menu of the OSD screen function. If you turn off the power before exiting the SCHEDULE menu, the schedule settings may be canceled.

NOTE

- Before making the schedule settings, be sure to check the current date and time using "DATE AND TIME".
 - When you close the SCHEDULE screen, the settings are saved.
 - When two or more schedules are enabled, they are executed according to the setting of the timer. If the time period overlaps between different schedules, the schedule changes to the schedule started later, and the power turns off once the last executed schedule has completed.
 - When two or more schedules have the same power-on/off time, the one with the smallest program number is executed.
 - When a schedule has been set, the off timer is disabled.
 - You cannot set the power-on time and the power-off time to the same time.
 - The power-off time cannot be set if the power-on time has not been set.
 - When the AC power supply turns off or the circuit breaker trips due to power failure or other causes, the schedule programs will be keep and executed when the AC power supply returns. However, system time will not be correct if the AC power is off for more than 168 hours.
-

Viewing media from USB storage

- 1 Insert USB storage medium into the USB port.
- 2 Use the SOURCE button on the infrared remote control or the LCD display to select USB as the input source.
- 3 The OSD will display three options, PHOTO, MUSIC, and MOVIE. Use the LEFT (◀), and RIGHT (▶), buttons on the infrared remote control to select the media type you wish to view, then enter your selection by pressing the OK button.

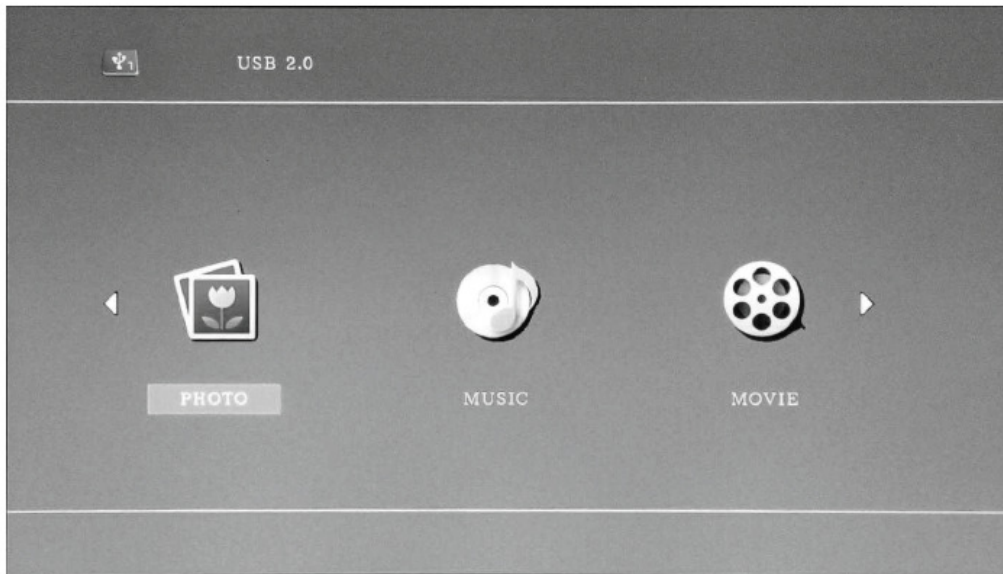

- 4 When available, the USB storage medium will display on the screen as drive C. Open this drive by pressing the OK button on the infrared remote control.
- 5 Use the UP (▲), and DOWN (▼), buttons on the infrared remote control to navigate the contents of the USB storage medium. Open the media you wish to view, using the OK button.



- 6 Use the audiovisual control buttons to navigate and open media files; fast reverse (◀◀), play (▶), fast forward (▶▶), track backwards (◀◀), stop (■), pause (⏸), and track forward (▶▶).
- 7 When media files are being viewed in this way, the colored buttons on the infrared remote control will be active. Their functions are determined by context, and will be shown in the OSD at the bottom of the LCD display. See page 52. The functions of the menu buttons on the LCD display will also change. The following table explains the different menu button functions according to media source.

Menu Button Functions According To Media Source			
Keypad Definition	Media Source		
Key name	Media Root page	Media list/playlist mode	Media player mode
Menu	Input source key	Exit	Exit
Input	OK	On file: play/pause On folder: OK key On dialog OSD: OK key	play/pause
Vol up	Right key	Right key	Vol up
Vol down	Left key	Left key	Vol down
Up	Up key	Up key	Next image/music file/ movie
Down	Down key	Down key	Previous image/music file/movie
Power	Power off	Power off	Power off

Setting up a playlist

- 1 Enter one of the media type menus (PHOTO, MUSIC or MOVIE).
- 2 The USB storage medium will display on the screen as drive C. Open this drive by pressing the OK button on the infrared remote control.

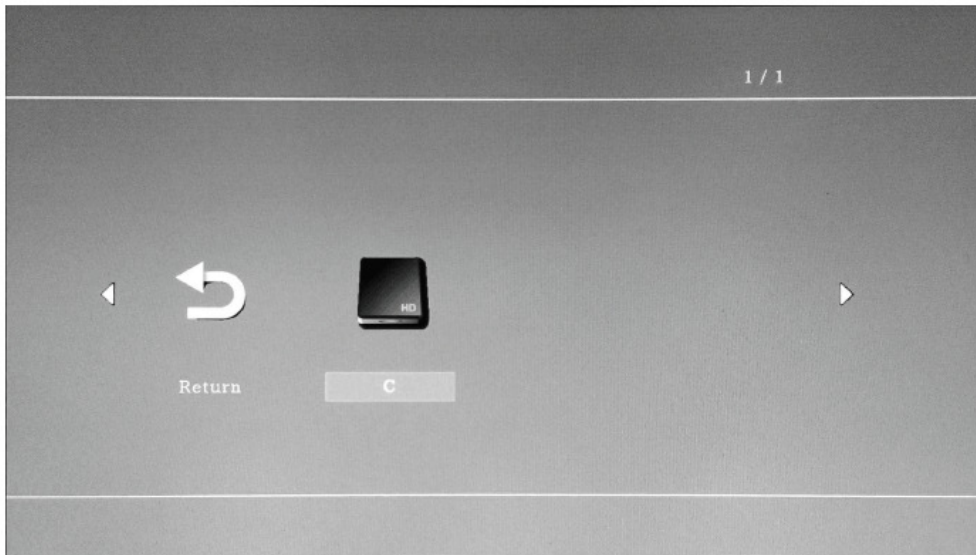

- 3 Use the UP (▲), and DOWN (▼), buttons on the infrared remote control to navigate the contents of the USB storage medium. Press the [RED] button to display playlist functions.
- 4 The playlist menu now displays. Use the UP (▲), and DOWN (▼), buttons on the infrared remote control to navigate and select files. Press the [OK] button to add a selected file to the playlist.

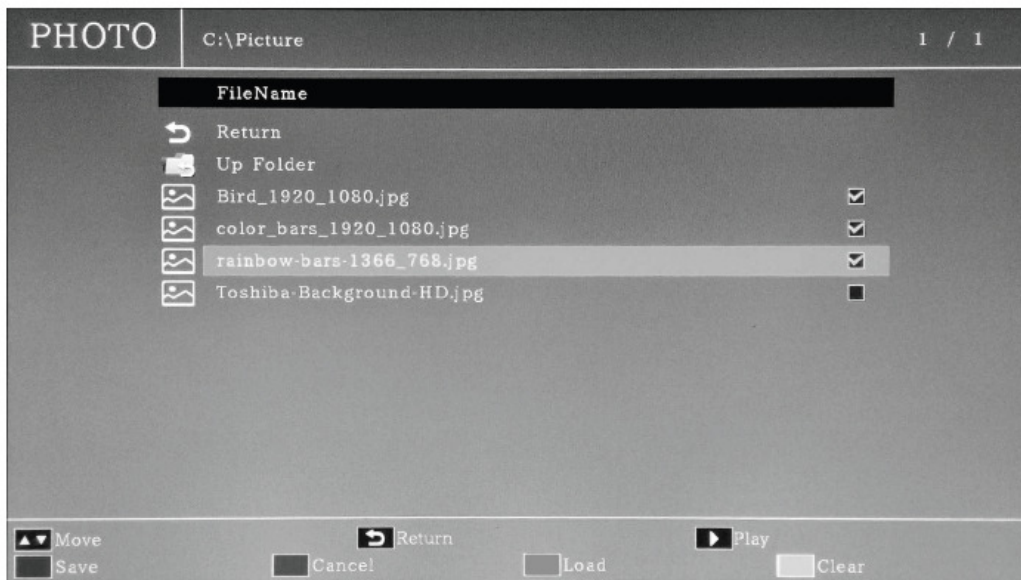

- 5 Use the colored buttons to select options in the playlist menu.
- [BLUE]: Save selected files to a playlist.
 - [RED]: Cancel and return to the previous menu.
 - [GREEN]: Load an existing playlist.
 - [YELLOW]: Clear all selected files from the current playlist.





- 6 If no playlist has been defined, pressing the [BLUE] button ([PLAY ALL]), or the [OK] button, or the PLAY button (▶), will play all files in the current folder.

Playing background music

 This is the background music icon. When viewing photos it is possible to play background music simultaneously if the folder from which the photos are being played also contains music, and the music has been added to a playlist.

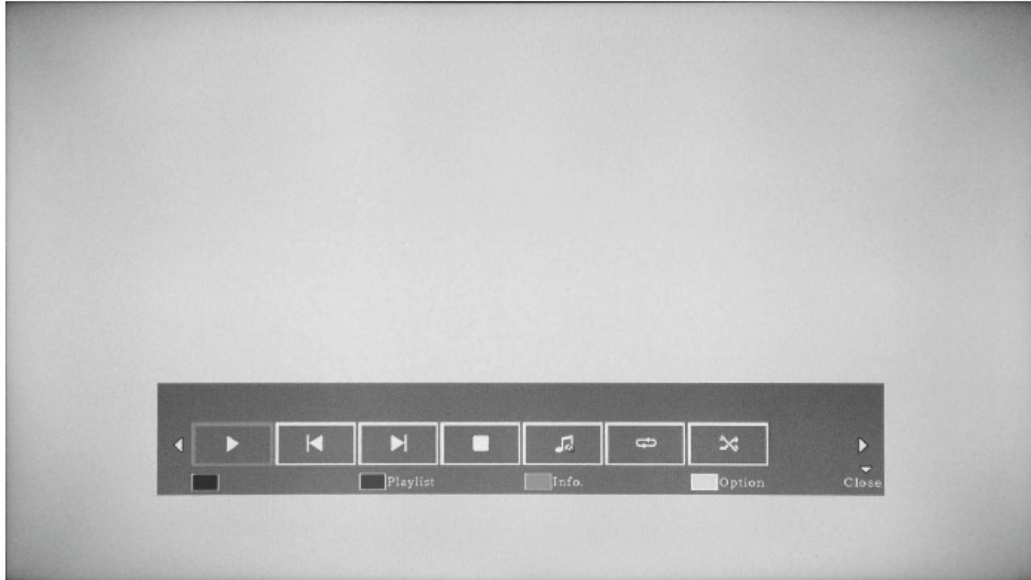
- 1 Press the UP () button to display the playguide.



- 2 Use the LEFT () and RIGHT () buttons to select the background music icon, and press [OK].
- 3 The background music icon will be crossed out if no music files are available to play.

Slideshow settings

When in photo viewing mode, it is possible to view all available photos (or all photos in a playlist), using a slideshow. Use the [YELLOW] button to display these slideshow options.

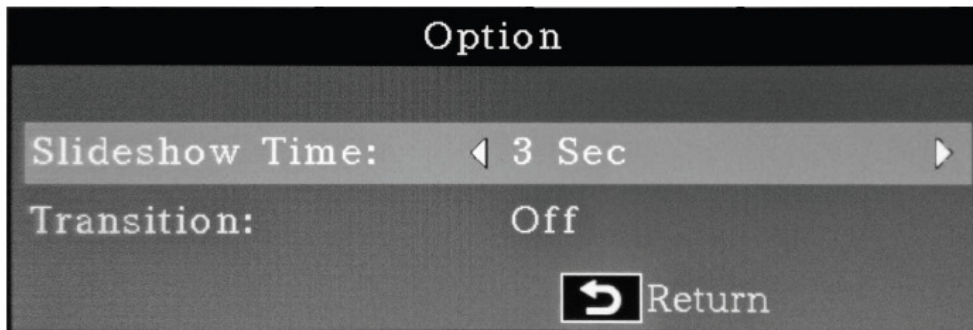



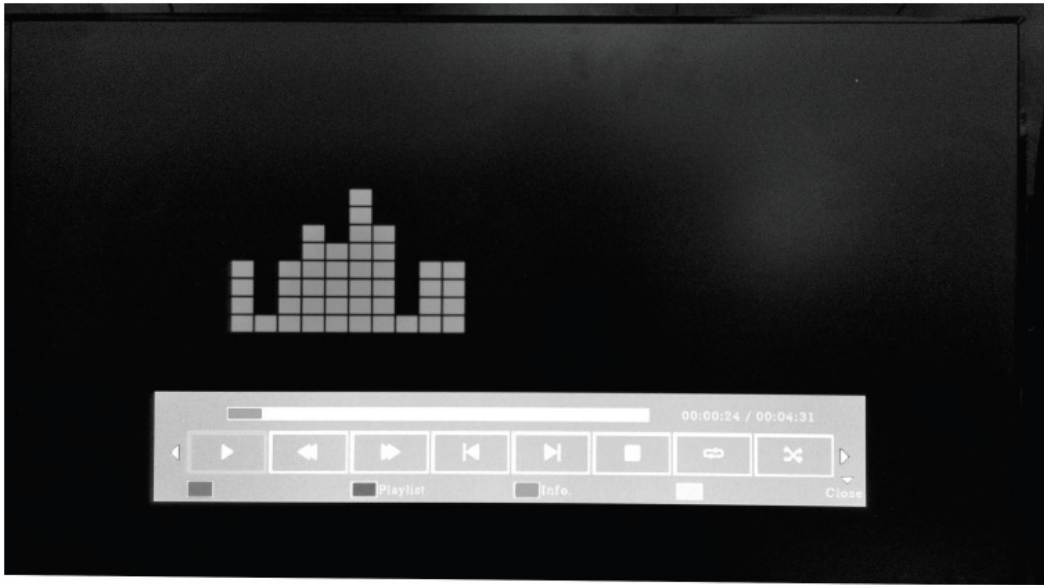

- 1 Slideshow Time:** Set the time to wait between presenting each image in the slideshow:
 - 3 seconds-20 seconds/1 second intervals
- 2 Transition:** Set the transition type when changing from one image in the slideshow to another.
 - Off
 - Wipe left
 - Wipe right
 - Wipe up
 - Wipe down
 - Box in
 - Box out













Playing a playlist





When playing a playlist, a playguide is available which provides additional functions. Use the UP (▲), button to display these functions, the LEFT (◀), and RIGHT (▶), buttons to select these functions, the [OK] button to choose a function, and the [INFO] button to hide the playguide.

Playguide Functions	
Remote Key	Function
/ ▶	Pause/play
▶▶	Fast forward (not available in PHOTO mode)
◀◀	Rewind (not available in PHOTO mode)
◀	Previous photo/track/file
▶	Next photo/track/file

Playguide Functions	
Remote Key	Function
	Stop playback
	Play/stop background music (only available in PHOTO mode, and is crossed out if this feature is unavailable)
	Repeat: play all files repeatedly in sequence
	Shuffle: play all files randomly

Remote Key Functions With Playguide			
Remote Key	Pictures	Music	Movies
	Show playguide	Show playguide	Show playguide
	Hide playguide	Hide playguide	Hide playguide
	Select item (play/pause/skip-up/skip-down/stop/music/repeat/shuffle/SSTime/SSTransition)	Select item (pause or play/fast forward/rewind/skip-up/skip-down/repeat/shuffle)	Select item (pause or play/fast forward/rewind/skip-up/skip-down/repeat/shuffle)
OK	Choose item (play/pause/skip-up/skip-down/stop/music/repeat/shuffle/SSTime/SSTransition)	Choose item (pause or play/fast forward/rewind/skip-up/skip-down/repeat/info)	Choose item (pause or play/fast forward/rewind/skip-up/skip-down/repeat/info)
	Play back selected item	Playback selected item	Playback selected item
	Stop and return to list window	Stop and return to list window	Stop and return to list window
	Pause slideshow	Pause playback	Pause playback
	Not used	Fast forward	Fast forward
	Not used	Rewind	Rewind
	Next photo	Next track	Next file
	Previous photo	Previous track	Previous file
[BLUE] 	Not used	Not used	Not used
[RED] 	[PLAYLIST]: Show playlist details	[PLAYLIST]: Show playlist details	[PLAYLIST]: Show playlist details

Remote Key Functions With Playguide			
Remote Key	Pictures	Music	Movies
[GREEN] 	[INFO]: Show details of current file	[INFO]: Show details of current file	[INFO]: Show details of current file
[YELLOW] 	[OPTION]: Slide show options	Not used	Not used
Info	Show/hide playguide	Show/hide playguide	Show/hide playguide
	Return to list window	Return to list window	Return to list window

Remote control

1 RS-232C Remote control

In order to control displays remotely, the displays support two communication interfaces: **RS-232C** and **LAN**. Computers can communicate to the display via the two connections. You can select communication interface in the OSD menu. The two connection types for connecting a computer to the display are shown as below:

i. RS-232C:

Using an RS-232C cross cable (reversed).

For connection with a 25-pin serial port connector on the computer, a conversion adapter (commercially available) is required.

For direct connection using RS-232C, use the RXD, TXD, and GND lines.

ii. LAN: Using a RJ45 connector for Ethernet networking.

By using the two communication interfaces, you can control displays remotely.

NOTE Please contact your local agent for details of the control functions, including command sets.

The following operations are supported control commands.

Control Command Function Overview	
Main operations	Description
Reset	Restoring settings to the defaults. Reset commands including Picture Reset, Sound reset, etc.
Power ON or OFF	Turn the LCD display on or off.
Volume control and mute	Adjusting the volume.
Input source	Switching between input signals.
Items about picture	Adjusting picture mode, backlight, over scan, etc
Items about sound	Adjusting sound mode, speaker, audio only, etc.
Items about multi-display control	Options used to set up multiple displays, such as screen position, display ID, etc.
Items about initial setting	Initial settings can also use command to adjust options, such as language, RTC time, time format, OSD rotation, etc. For example, selecting the language can change the on-screen menu language.

2 Command protocol

- i. The communication protocol setting is as follows:

Communication Settings	
Protocol	RS-232C
Baud rate	9600 [bps]
Data length	8 [bit]
Parity bit	None
Stop bit	1 [bit]
Flow control	None

- ii. Control command protocol:

The command is structured by the **command length code**, **ID code**, **command type code**, **function code**, **data code** and **end code**. The length of the command is different for each function.

Command Protocol	
Command length code	Total byte of message excluding end code.
ID code	Identification for each of the displays.
Command type code	0x73: Set command; 0x67: Get command; 0x72: Reply command; 0x2B: Valid command reply; 0x2D: Invalid command reply
Command code	Each control function is assigned to a unique command code.
Data code (value)	Value of each control function
End code (CR)	0x0D

A remote tool (terminal software), helps users send control commands more conveniently. When you use the terminal software, you can adjust the timeout period in the user interface. The default timeout value is 5,000ms. If the computer does not acknowledge the message within the timeout period, a transmission error is assumed to have occurred. If the LCD display receives the command, it will send a return command to the computer. The computer checks the return command to see whether or not the command it sent was received, and must receive the return command before sending the next command.

Two basic commands are shown here as examples. Note that these commands are used when a single computer connects to a single display. Contact your dealer for advanced command specifications if you want to connect multiple displays, or perform complicated controls using other commands than the basic commands.

Example 1: Set display ID-02 brightness to 76; this command is valid.

Send packet from computer									
Byte	0	1	2	3	4	5	6	7	8
Name	Length (1 byte)	ID (2 bytes)		Cmd Type (1 byte)	Cmd Code (1 byte)	Value (>= 3 bytes)			CR (1 byte)
						Byte1	Byte2	Byte3	
Hex	0x38	0x30	0x32	0x73	0x24	0x30	0x37	0x36	0x0D

Return packet from display to computer					
Byte	0	1	2	3	4
Name	Length	0x32		Cmd Type	CR
Hex	0x34	0x30	0x32	0x2B	0x0D

Example 2: Retrieve brightness value from display ID-02; this command is valid, and the brightness value is 80.

Send packet from computer									
Byte	0	1	2	3	4	5	6	7	8
Name	Length (1 byte)	ID (2 bytes)		Cmd Type (1 byte)	Cmd Code (1 byte)	Value (>= 3 bytes)			CR (1 byte)
						Byte1	Byte2	Byte3	
Hex	0x38	0x30	0x32	0x67	0x62	0x30	0x30	0x30	0x0D

Return packet from display to computer									
Byte	0	1	2	3	4	5	6	7	8
Name	Length (1 byte)	ID (2 bytes)		Cmd Type (1 byte)	Cmd Code (1 byte)	Value (>= 3 bytes)			CR (1 byte)
						Byte1	Byte2	Byte3	
Hex	0x38	0x30	0x32	0x72	0x62	0x30	0x38	0x30	0x0D

LAN remote control

When you connect the display and the computer using a LAN hub and a LAN cable (see page 31), and then configure the network settings using ETHERNET SETTING in the SETUP menu of the OSD, you can control the LCD display remotely using the same commands as for RS-232C.

Setting procedure:

- 1** Select LAN as the communication interface used for the serial communication function. (See page 55, and see also the Control Setting in the "Setup Menu Screen" on page 65).
- 2** Set the following network parameters using the OSD menu.
 - DHCP client ON/OFF, IP address, subnet mask and default gateway.
- 3** Set the IP address described above and the port number (4660) using the application program of your computer to perform the socket communication.
- 4** Send the same control command as for RS-232C via TCP/IP socket communication.
- 5** Check the return command sent from the LCD display. When it is received successfully, the setting is complete.

Configuration and basic operation of the OSD screen

This LCD display is equipped with an OSD (On Screen Display) function for easy adjustment of settings. The OSD function allows you to control the menus displayed on the screen, to adjust brightness, and other settings.

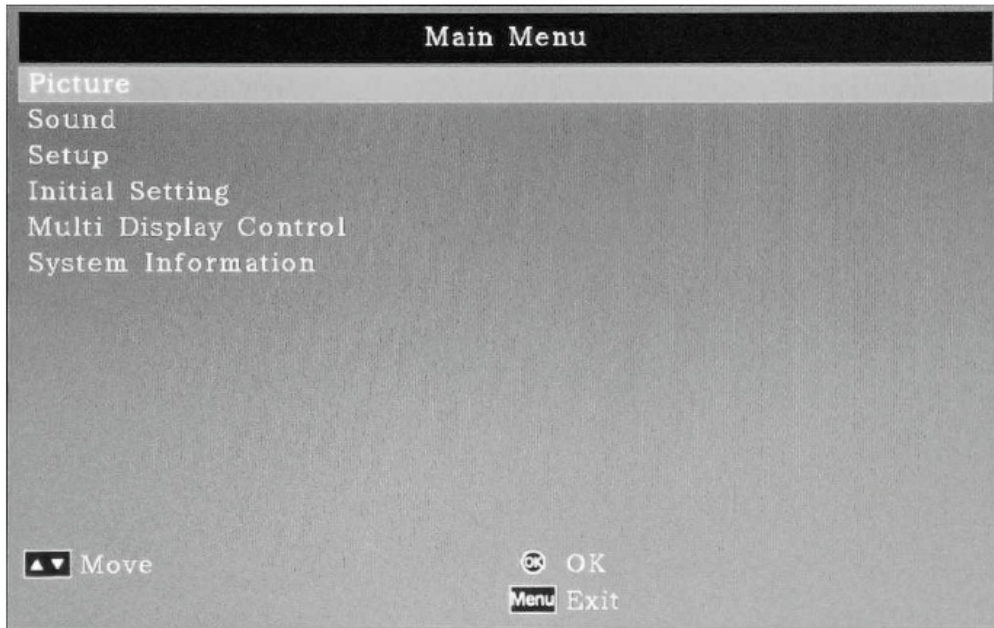









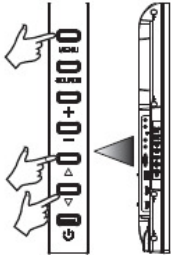
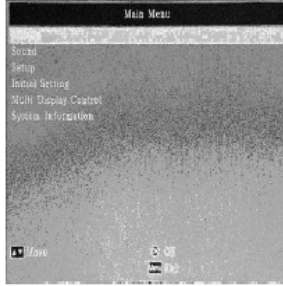

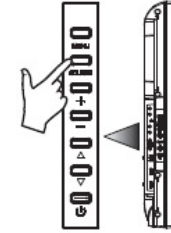
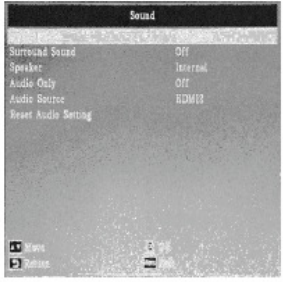

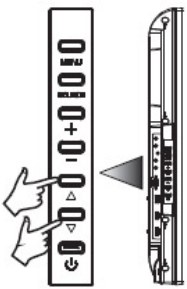
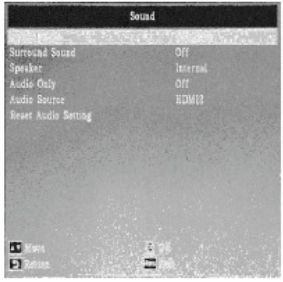
This table lists the initial OSD functions in the main menu screen. Detailed options are described in the following pages.

Main Menu Screen	
Menu Option	Detailed information
Picture	See page 62
Sound	See page 64
Setup	See page 65
Initial Setting	See page 66
Multi Display Control	See page 67
System Information	See page 69

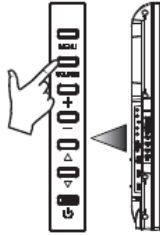
Basic operation of OSD screen

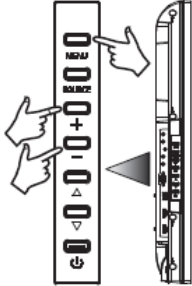
Check that the power indicator illuminates green and the LCD display is powered on.

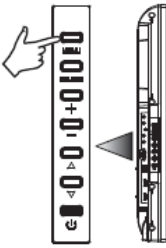
Step	Infrared remote control	Monitor button	Description
1	 <p data-bbox="375 712 676 875">Press the MENU button to display the OSD screen and then press the UP (▲), and DOWN (▼), buttons to select options in the main menu.</p>		
2	 <p data-bbox="375 1086 676 1198">When you press the OK button to accept the selected main menu, the sub menu at the top is selected.</p>	 <p data-bbox="703 1173 995 1301">When you press the SOURCE button to accept the selected main menu, the sub menu at the top is selected.</p>	
3	 <p data-bbox="375 1659 612 1738">Press the UP (▲), and DOWN (▼), buttons to select a sub menu.</p>		

Step	Infrared remote control	Monitor button	Description
4	 <p>Press the OK button to accept the selected sub menu.</p>	 <p>Press the SOURCE button to accept the selected sub menu.</p>	
5	 <p>Press the LEFT (◀), and RIGHT (▶), buttons to select the setting and then press the OK button to accept it.</p>	 <p>Press the PLUS (+), and MINUS (-), buttons to select the setting and then press the MENU button to accept it.</p>	
6	 <p>Press the exit button to leave the current menu and return to the previous menu.</p>	 <p>Press the MENU button to leave the current menu.</p>	

Picture Menu Screen

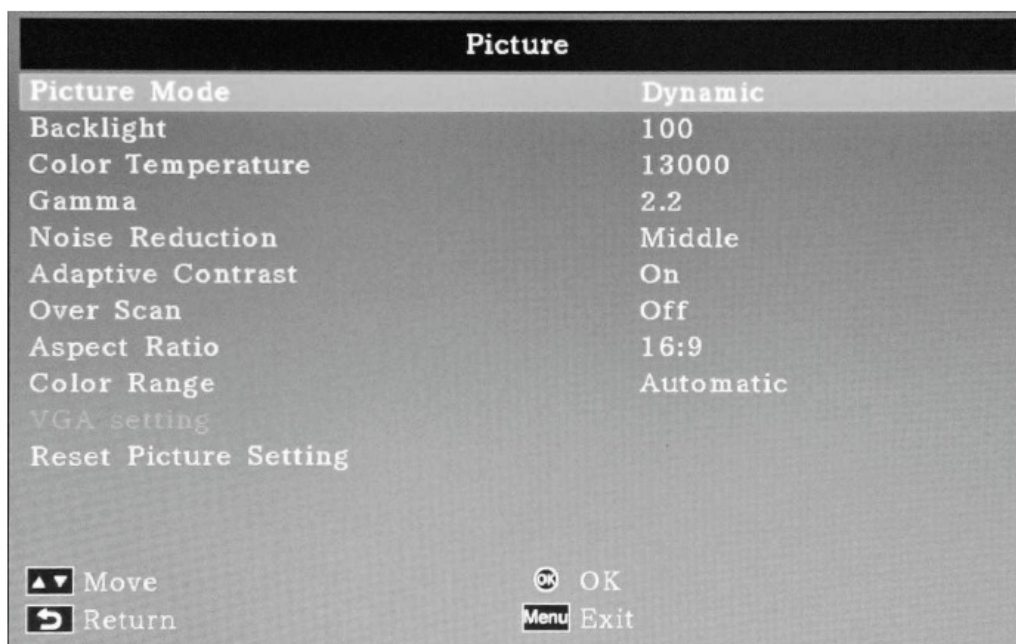

Picture Menu Screen	
Picture mode	Select picture style, Dynamic, Cinema, Custom, or Standard. See pages 16 and 41.
	Adjust contrast, brightness, sharpness, tint, and color settings.
Backlight	Adjust backlight settings.
Color Temperature	Adjust color temperature and gain.
Gamma	Select gamma setting.
Adaptive Contrast	Turn adaptive contrast on or off.
Over Scan	Adjust over scan settings.
Aspect Ratio	<ul style="list-style-type: none"> Adjust aspect ratio settings This option is grayed out and inactive when the zoom (in multi-display), is enabled. The options are 4:3, 16:9, zoom, cinema, and dot by dot. If overscan is off, only aspect ratios 4:3, 16:9, and dot by dot can be selected. If multi-display is active, the overscan option is grayed out and set to OFF.
Color Range	Adjust color range settings, or set to automatic.
VGA setting	Adjust horizontal and vertical position, clock, and phase.
Reset Picture Setting	Reset settings to factory defaults.

Aspect Ratio Menu Settings

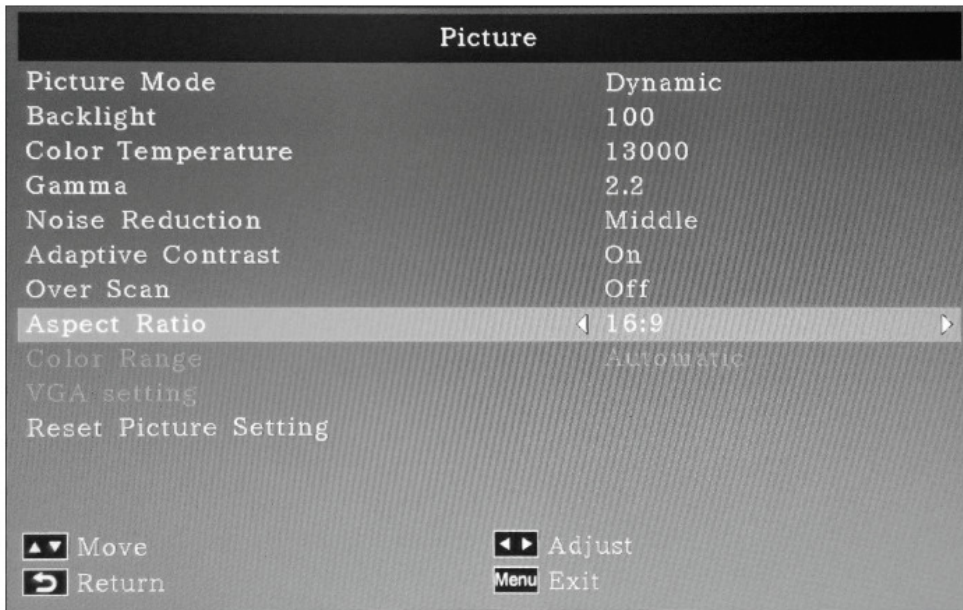

Aspect Ratio Menu Settings		
Source ID	OverScan	Aspect Ratio
HDMI1/2 DVI-D YPrPr PC	OFF	4:3 16:9 Dot by Dot
	Auto	4:3 16:9 Zoom Cinema Dot by Dot
AV	Auto	4:3 16:9 Zoom Cinema
Media Movie	OFF	4:3 16:9 Dot by Dot
	Auto	4:3 16:9 Zoom Dot by Dot

Sound Menu Screen

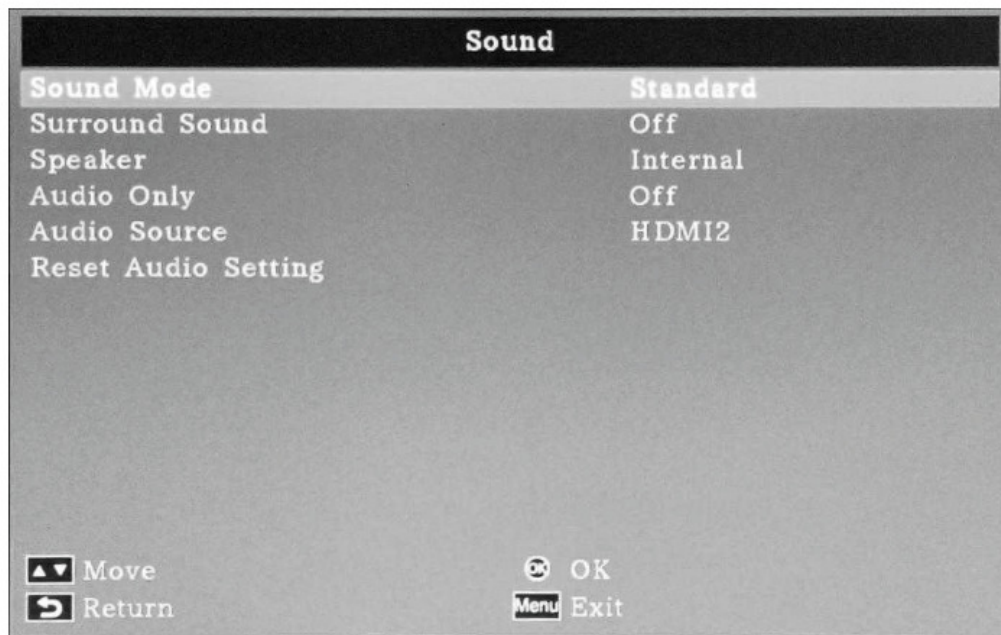

Sound Menu Screen	
Sound mode	Select sound style; Standard, Dynamic, or Custom.
	Adjust Treble, Bass, and Balance settings.
Surround Sound	Turn surround sound on or off.
Speaker	Select internal or external speaker.
Audio Only	Select audio only, or audio/video.
Audio Source	Select audio source; Line In/HDMI1, or Line In/HDMI2.
Reset Sound Setting	Reset settings to factory defaults.

Setup Menu Screen

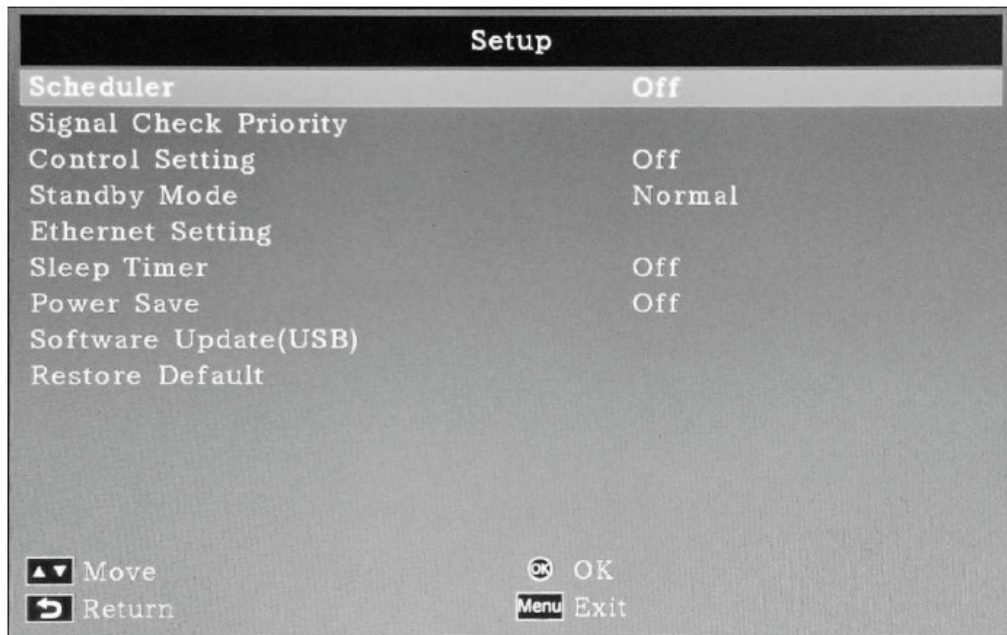

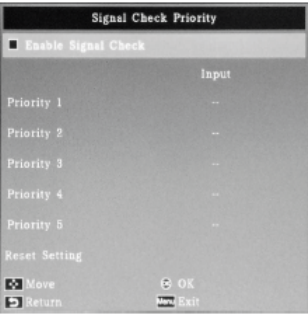
Setup Menu Screen	
Scheduler	Change schedule settings.
Signal Check Priority 	<ul style="list-style-type: none"> • Set signal priority 1-5 (priority 1 is the highest). If the current source signal is lost, the display will search for a new signal source according to signal priority setting). • If signal priority check is enabled, upon power on the display will search for an active source according to the signal priority check settings. • If there is no signal source available in priority 1, the display will check other sources in descending order of priority, and switch source accordingly. • If the signal source with the highest priority returns, the display will automatically switch back to this source. • If signal priority check is disabled, upon power on the display will use the last used source. • If signal priority check is enabled and upon power on the source is USB, the system will automatically play from USB.
Control Setting	Choose to control the LCD display through RS-232C or LAN.
Standby Mode	Select standby mode; ECO or normal.
Ethernet Setting	Change ethernet settings for control via LAN.
Sleep Timer	Change sleep timing settings, or turn off the sleep timer.
Power Save	Change power save settings, or turn off the power save mode.

Setup Menu Screen	
Software Update (USB)	Update software through the USB port.
Restore Default	Reset settings to factory defaults.

Initial Setting Menu Screen

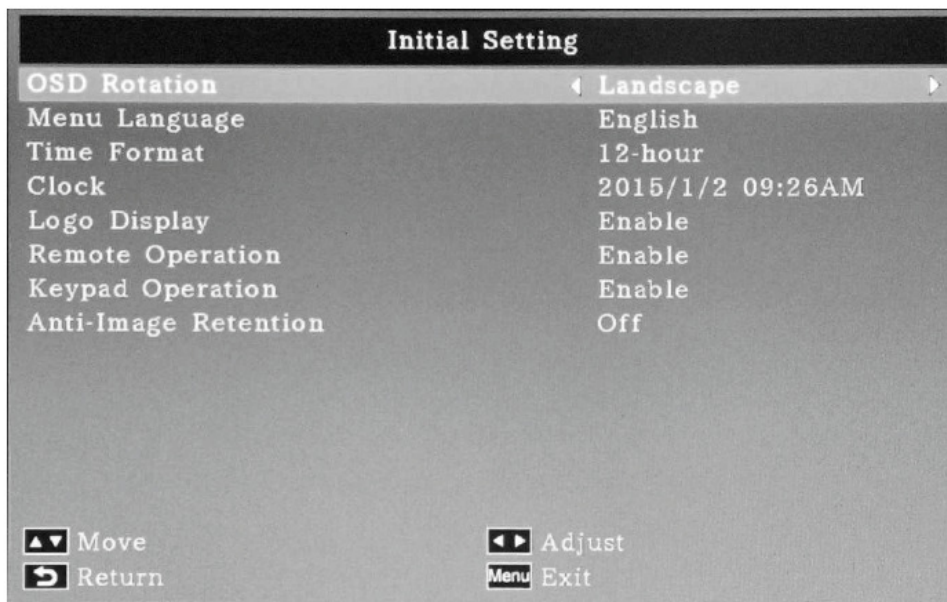

Initial Setting Menu Screen	
OSD Rotation	Selects portrait or landscape orientation for the OSD.
Menu Language	Change the OSD menu language.
Time Format	Selects 12 hour or 24 hour time format.
Clock	Change time and date.
Logo Display	Select whether or not to display the logo on power up.
Remote Operation	Enable or disable remote operation.
Keyboard Operation	Enable or disable keyboard operation.
Anti-Image Retention	Select one of two image retention prevention modes, or turn it off.

Multi Display Control Menu Screen

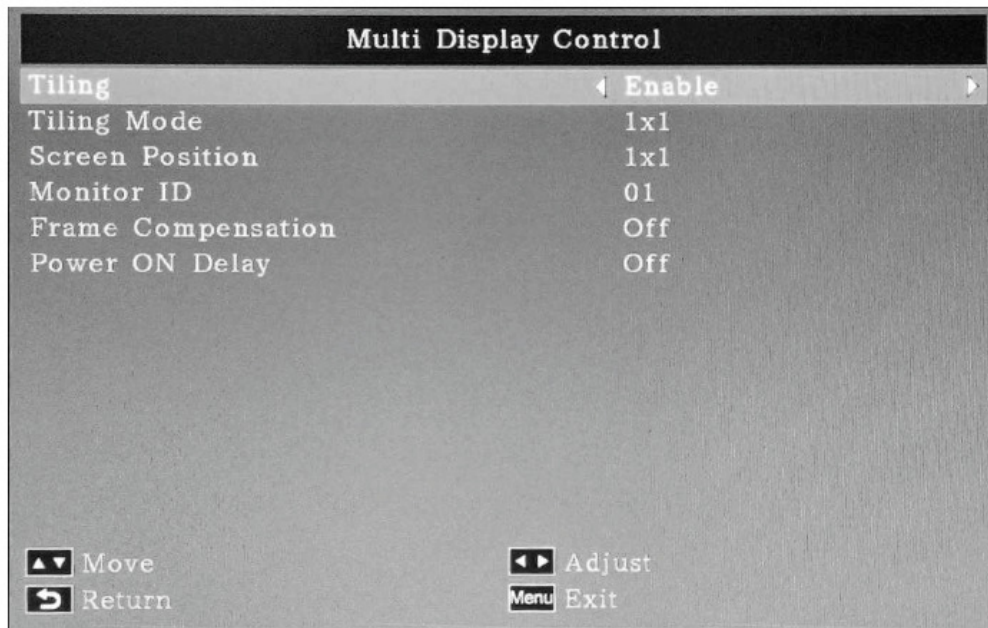

Multi Display Control Menu Screen	
Tiling	Enable Multi Display. Up to 25 panels (5 wide x 5 high), can be combined to create a single large image (i.e., video wall), or other high-impact signage.
Tiling Mode	Set the number of displays used for the horizontal and vertical display.
Screen Position	For installations when Tiling mode is setup for a video wall, to decide the display area by screen position
Monitor ID	Set the monitor ID number that is used for identification, especially when the "SET ID" key of the infrared remote controller and the control function by RS-232C are used
Frame Compensation	Turn frame compensation on or off. Frame compensation is used to compensate for the width of panel bezels so images are displayed with high accuracy.

Multi Display Control Menu Screen	
Power ON Delay	<p>For installations using multiple displays, the power-on delay function can power up the displays sequentially with a delay of 0-30 seconds after the power is applied. Using this function can prevent inrush current problems, and reduce the overall electrical load requirements when a single power supply is used.</p> <ul style="list-style-type: none"> • Set the power on delay or turn it off. • 0-30 seconds/0.5 second steps. • Set to "AUTO" by default. • This function is interlocked with the number of the display ID. • When multiple displays are used, each display is assigned an individual display ID. • For "Power On Delay", when "AUTO" is chosen, each display's power supply delay time is defined as follows. <ul style="list-style-type: none"> • Delay time = number of display ID × 0.3 seconds. • For example, for a display in which display ID is set to 5, the power supply is turned on after 1.5 seconds.

Controlling Multiple Displays

Use these instructions to set a display's ID number with the infrared remote control.

- 1 Press [MENU].
- 2 Use the DOWN button (▼), to move to the option "Multi Display Control", and press [OK].
- 3 Use the LEFT (◀), and RIGHT (▶), buttons to select the display's two digit ID.
- 4 Exit the menu by pressing the [MENU] button.

Use these instructions to select a display to control with the infrared remote control. Display IDs have two digits. In this example the selected display's ID is "02".

- 1 Press [SET ID]. The OSD will display "IR Set ID".
- 2 Press "0". The OSD will display "IR Set ID 0".
- 3 Press "2". The OSD will display "IR Set ID 02".
- 4 Press [ENTER]. If the display's ID is "02", the OSD will display "IR Free 02".
- 5 If the display's ID is not "02", the OSD will display "IR Lock 02".
- 6 To clear the lock status, press [SET ID].

Use the [INFO] button to identify the current display's ID. The OSD will display the ID. To reset all display IDs in the daisy chain, press [SET ID], "0", "0", then [ENTER].

System Information Menu Screen

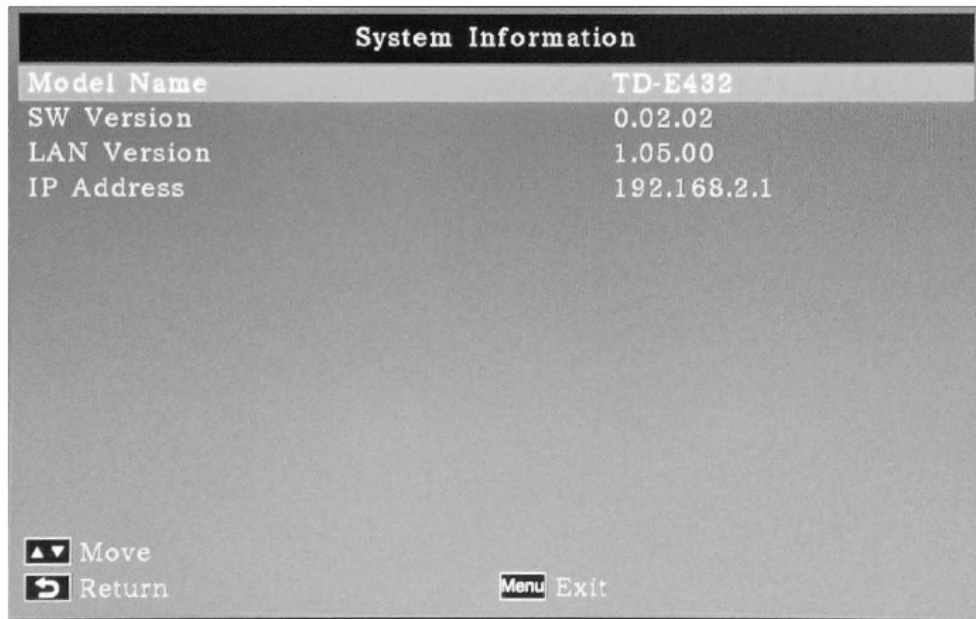

System Information Menu Screen	
Model Name	Shows the display's model name and number.
SW Version	Shows the display's current software version.
LAN Version	Shows the display's current LAN firmware version.
IP Address	Shows the display's current IP address.

Appendix A

Specifications

NOTE

- These models comply with the specifications listed below.
 - Designs and specifications are subject to change without notice.
 - These models may not be compatible with features and/or specifications that may be added in the future.
-

LCD Module

LCD Module	43"	50"	55"	65"
Screen size	43"	50"	55"	65"
Panel Type	VA	VA	VA	VA
Pixel Pitch (mm)	0.49 x 0.49	0.57 x 0.57	0.63 x 0.63	0.744 x 0.744
Resolution	1920 x 1080 pixels	1920 x 1080 pixels	1920 x 1080 pixels	1920 x 1080 pixels
Color	8 bit 1.67 million colors	8 bit 1.67 million colors	8 bit 1.67 million colors	10 bit 1.06 billion colors
Brightness (cd/m2, typ.)	450	450	450	450
Contrast ratio	3000	3000	3,500	4,000
Viewing Angle (CR>=10)	Up/Down 89° Left/Right 89°	Up/Down 89° Left/Right 89°	Up/Down 89° Left/Right 89°	Up/Down 89° Left/Right 89°
Response time	8ms (G to G)	8ms (G to G)	8ms (G to G)	8ms (G to G)

Main power switch

(sample illustration) 43" power switch

Viewable Size (H x V)

43"	940.9 x 529.3mm
50"	1095.8 x 616.4mm
55"	1209.6 x 680.4mm
65"	1428.5 x 803.5mm

Power Management

VESA DPM

Power source

	43"/50"/55"/65"
Input Voltage	AC100-240V \pm 10% (50/60Hz)
Power Consumption in Power Saving mode	Power switch off (DC-OFF, standby): <0.5W Main power switch off: 0W

Power consumption

43"	~90W
50"	~170W
55"	~180W
65"	~226W

Input/Output Signal

PC Input/Output

Input Connector	Analog	D-SUB 15-pin or YPbPr cable (YPbPr CVBS Common)
	Digital	HDMI x 2 (PC/AV Common, HDCP supported), DVI-D (HDCP supported)
Output Connector	Digital	DVI-D (HDCP supported)
Horizontal Frequency	Analog: 15.625 kHz - 67.5 kHz, Digital: 31.5 kHz - 67.5 kHz	
Vertical Frequency	50 Hz - 60 Hz	
Pixel Clock	Analog	13.5 - 148.5.0 MHz
	Digital	25.0 - 148.5.0 MHz
Video Signal	Analog: Analog RGB, Digital: TMDS (with HDCP)	
Sync Signal	Analog: Separate (TTL), Composite (TTL), Sync on Green, Digital: TMDS	

Supported Resolutions	Analog: 640 x 480, 720 x 400, 800 x 600, 1024 x 768, 1280 x 768, 1280 x 800, 1280 x 960, 1280 x 1024, 1360 x 768, 1366 x 768, 1600 x 1200, 1920 x 1080 Digital: 640 x 480, 800 x 600, 1024 x 768, 1280 x 1024, 1280 x 768, 1360 x 768, 1680 x 1050, 1920 x 1080
-----------------------	--

AV Input/Output

Input Connector	Analog	Composite (shared with Component Y/Pb/Pr), D-SUB 15-pin or YPbPr cable
	Digital	HDMI x 2 (HDCP supported), DVI-D (HDCP supported), USB
Output Connector	Digital	DVI-D (HDCP supported)
Supported Resolution	Composite/S-terminal: SDTV, DVD, HDTV Component: 480i, 480p, 576i, 576p, 720p, 1080i, 1080p	

Audio Input/Output

Input Connector	Analog	3.5mm jack
	Digital	HDMI x 2 (digital audio)
Output Connector	Analog	3.5mm jack

Dimensions

43"	Width	38.1" (967mm)
	Height	22.4" (568mm)
	Depth	2.8" (70mm)
50"	Width	44.6" (1133mm)
	Height	25.8" (656mm)
	Depth	2.8" (70mm)
55"	Width	49.0" (1246mm)
	Height	28.3" (719mm)
	Depth	2.7" (69mm)
65"	Width	57.6" (1463mm)
	Height	33.2" (844mm)
	Depth	2.8" (70mm)

Mass (weight)

43"	Net 10.5kg (23.1lb); Gross 15.0kg (33.0lb)
50"	Net 14.0kg (30.9lb); Gross 20.5kg (45.2lb)
55"	Net 17.0kg (37.5lb); Gross 24.0kg (52.9lb)
65"	Net 24.0kg (52.9lb); Gross 33.5kg (73.9lb)

Table 1: Media Support Specifications (Video)

File Extension	Container	Video codec	Maximum Resolution	Max Frame Rate	Max Bit Rate	MPEG1 (L2& L3)	AC3	AAC	WMA	L-PCM	
.dat .mpg .mpeg	MPG	MPEG1	1080P	30fps	20Mbit/Sec	V	V	V		V	
	MPEG	MPEG2	1080P	30fps	20Mbit/Sec						
.ts .trp .to .m2ts	TS	MPEG2	1080P	30fps	20Mbit/Sec	V	V	V			
		H.264	1080P	30fps	20Mbit/Sec						
.vob	MPEG2-PS	MPEG2	1080P	30fps	20Mbit/Sec	V	V			V	
.mp4	MP4	MPEG4 H.264	1080P	30fps	20Mbit/Sec	V		V			
			1080P	30fps	20Mbit/Sec						
.mkv	MKV	H.264	1080P	30fps	20Mbit/Sec	V	V	V			V
		MPEG1	1080P	30fps	20Mbit/Sec						
		MPEG2	1080P	30fps	20Mbit/Sec						
		MPEG4	1080P	30fps	20Mbit/Sec						
.avi	AVI	MPEG2	1080P	30fps	20Mbit/Sec	V	V	V			V
		MPEG4	1080P	30fps	20Mbit/Sec						
		H.264	1080P	30fps	20Mbit/Sec						

Table 1: Media Support Specifications (Video)

File Extension	Container	Video codec	Maximum Resolution	Max Frame Rate	Max Bit Rate	MPEG1 (L2& L3)	AC3	AAC	WMA	L-PCM
Motion JPEG	AVI, MOV	JPEG	640x480	30fps	10Mbit/Sec					
.asf	ASF	H.264	1080P	30fps	20Mbit/Sec	V	V		V	V
		MPEG2	1080P	30fps	20Mbit/Sec					
		MPEG4	1080P	30fps	20Mbit/Sec					
		VC1	1080P	30fps	20Mbit/Sec					
		WMV3	1080P	30fps	20Mbit/Sec					
.wmv	ASF	MPEG4	1080P	30fps	20Mbit/Sec				V	

Table 2: Media Support Specifications (Audio)

File Extension	Audio codec	Bit Rate	Sample Rate
.mp3	MPEG1 Layer2	32Kbps - 448Kbps	32Khz - 48Khz
.mp3	MPEG1 Layer3	32kbps - 320Kbps	32Khz - 48Khz
N/A (works with video files only)	AC3	32kbps - 640Kbps	32Khz, 44.1Khz, 48Khz
.m4a .AAC	AAC, HEAAC	24Kbps - 384Kbps	8Khz - 48Khz
.wma .asf	WMA	128bps - 320Kbps	8Khz - 48Khz
N/A (work with video files only)	LPCM	64Kbps - 1.5 Mbps	8Khz - 48Khz

Table 3: Media Support Specifications (Photos)

File Extension	Image	Photo	Resolution
.jpg	JPEG	Base-line	15360x8640
		Progressive	1024x768

Table 3: Media Support Specifications (Photos)

File Extension	Image	Photo	Resolution
.png	PNG	non-interlace	9600x6400
		interlace	1200x800
.bmp	BMP		9600x6400

Table 4: Media Support Specifications (Internal Subtitles)

File Extension	Container	Subtitle Codec
.dat .mpg .mpeg .vob	MPG	DVD Subtitle
	MPEG	
.ts .trp .tp"	TS	DVB Subtitle
.mp4	MP4	DVB Subtitle
		UTF-8 Plain Text
.mkv	MKV	DVD Subtitle
		UTF-8 Plain Text
		ASS
		SSA
		Universal Subtitle Formate
	VobSub	
.avi	AVI	XSUB

Table 5: Media Support Specifications (External Subtitles)

File Extension	Container	Remark
.srt	SubRip	
.ssa	SubSation Alpha	
.ass	SAMI	
.smi		

Table 5: Media Support Specifications (External Subtitles)

File Extension	Container	Remark
.sub	SubViewer	SubViewer 1.0 & 2.0 Only
	MicroDVD	
	DVDSubtitleSystem	
	SubIdx(VobSub)	
.txt	TMPlayer	