



Digital Projector

# User Manual

Portable Entertainment Series | GVI

V 1.00

# Copyright and disclaimer

## Copyright

Copyright © 2018 by BenQ Corporation. All rights reserved. No part of this publication may be reproduced, transmitted, transcribed, stored in a retrieval system or translated into any language or computer language, in any form or by any means, electronic, mechanical, magnetic, optical, chemical, manual or otherwise, without the prior written permission of BenQ Corporation.

All other logos, products, or company names mentioned in this manual may be the registered trademarks or copyrights of their respective companies, and are used for informational purposes only.

*Android™ is a trademark of Google LLC.*

The Bluetooth® word mark and logos are registered trademarks owned by Bluetooth SIG, Inc. and any use of such marks by BenQ Corporation is under license.

iOS is a trademark or registered trademark of Cisco in the U.S. and other countries and is used under license.

macOS® is a trademark of Apple Inc., registered in the U.S. and other countries.

USB-C™ is a trademark of the USB Implementers Forum.

## Disclaimer

BenQ Corporation makes no representations or warranties, either expressed or implied, with respect to the contents hereof and specifically disclaims any warranties, merchantability or fitness for any particular purpose. Further, BenQ Corporation reserves the right to revise this publication and to make changes from time to time in the contents hereof without obligation of BenQ Corporation to notify any person of such revision or changes. This user manual aims to provide the most updated and accurate information to customers, and thus all contents may be modified from time to time without prior notice. Please visit <http://www.benq.com> for the latest version of this manual.

## Warranty

BenQ warrants this product against any defects in material and workmanship, under normal usage and storage.

Proof of purchase date will be required with any warranty claim. In the event this product is found to be defective within the warranty period, BenQ's only obligation and your exclusive remedy shall be replacement of any defective parts (labor included). To obtain warranty service, immediately notify the dealer from which you purchased the product of any defects.

Important: The above warranty shall be void if the customer fails to operate the product in accordance with BenQ's written instructions, especially the ambient humidity must be in-between 10% and 90%, temperature in-between 0°C and 40°C, altitude lower than 2000 meters, and avoiding to operate the projector in a dusty environment. This warranty gives you specific legal rights, and you may have other rights which vary from country to country.

For other information, please visit [www.BenQ.com](http://www.BenQ.com).

## Statement regarding hyperlinks and third-party websites

BenQ is not responsible for the content of the websites or of similar resources, which are maintained and controlled by third parties, that may be linked from this product. Providing links to those websites or to similar resources does not mean that BenQ makes any warranty or representation to their content by expression or by implication.

Any third party content or service preinstalled in this product is provided "as is". BenQ does not, by expression or by implication, make any warrant to the content or to the services provided by third parties. BenQ does not warrant or guarantee that the content or services provided by third parties are accurate, effective, most up-to-date, legal, or complete. Under no circumstances shall BenQ be liable for the content or services provided by third parties including their negligence.

Services provided by third parties may be terminated temporarily or permanently. BenQ does not warrant or guarantee that any content or services provided by third parties are in good condition at any time, and is not liable for the termination of the said content and services.

In addition, BenQ is not involved in any transactions you conduct in the websites or similar resources maintained by third parties.

You should contact the content or service providers for any questions, concerns, or disputes.

## Table of contents

Copyright and disclaimer .....	2
Copyright .....	2
Disclaimer .....	2
Warranty .....	2
Statement regarding hyperlinks and third-party websites .....	3
Package contents .....	11
Standard accessories .....	11
Introduction .....	13
Projector features .....	13
Projector exterior view .....	15
Front and left side view .....	15
Rear and right side view .....	16
Bottom view .....	17
Controls and functions .....	18
Control panel .....	18
LED Indicators .....	19
Remote control .....	21
Activating the remote control battery .....	22
Replacing the remote control battery .....	23
Remote control effective range .....	24
Installation .....	25

Choosing a location .....	25
Obtaining a preferred projected image size .....	27
Projection dimensions .....	27
Operations .....	29
Attaching the plug head.....	29
Removing the plug head.....	29
Charging the battery.....	30
Starting up the projector .....	31
Shutting down the projector .....	35
Adjusting the projected image .....	36
Adjusting the projection angle.....	36
Fine-tuning the image clarity .....	37
Correcting keystone .....	38
<b>BenQ Launcher</b> .....	39
The <b>BenQ Launcher</b> home page.....	39
Navigating the <b>BenQ Launcher</b> home page.....	40
Using the <b>BenQ Launcher Settings</b> menus .....	41
Inputting text .....	41
Connections .....	43
Wireless Connections .....	45
Connecting the projector to a Wi-Fi network.....	45
Wireless Projection for iOS & macOS®.....	47
Wireless Projection for Android™ .....	50
Wireless Projection for PC.....	52
Wi-Fi Hotspot .....	54

Wired Connections.....	58
Connecting a USB-C™ device with DisplayPort.....	58
Connecting a USB-C™ device without DisplayPort .....	61
Connecting a USB-C™ flash drive.....	62
Media Player .....	63
Bluetooth Connections .....	71
Pairing/Connecting to a Bluetooth speaker or headphones .....	71
Using the Projector as a Bluetooth speaker .....	73
Navigating the <b>Settings</b> menu .....	75
About the <b>Settings</b> menu.....	75
Using the <b>Settings</b> menu .....	76
<b>Picture</b> .....	77
<b>Sounds</b> .....	79
<b>Wi-Fi</b> .....	80
<b>Bluetooth</b> .....	81
<b>Hotspot</b> .....	82
<b>Installation</b> .....	83
<b>Preference</b> .....	84
<b>About</b> .....	85
Maintenance .....	86
Care of the projector.....	86
Cleaning the lens .....	86
Storing the projector.....	86
Transporting the projector .....	87
Extending LED life.....	87
Troubleshooting .....	89
Specifications .....	91
Projector specifications .....	91

Dimensions.....	93
Timing chart.....	94
Supported file formats.....	96

# Important safety instructions

Your projector is designed and tested to meet the latest standards for safety of information technology equipment. However, to ensure safe use of this product, it is important that you follow the instructions mentioned in this manual and marked on the product.

1. Please read this user manual before you operate your projector.  
Keep this manual in a safe place for future reference.

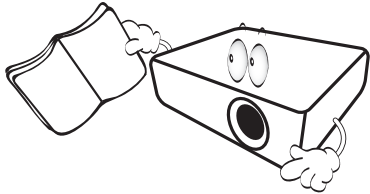

2. Always place the projector on a level, horizontal surface during operation.
  - Do not place the projector on an unstable cart, stand, or table as it may fall and be damaged.
  - Do not place inflammables near the projector.
  - Do not use if tilted at an angle of more than 10 degrees left to right, nor at angle of more than 15 degrees front to back.

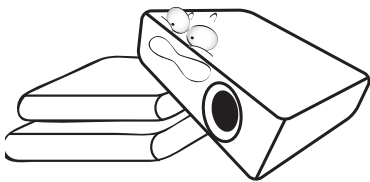

3. Do not store the projector on end vertically. Doing so may cause the projector to fall over, causing injury or resulting in damage.

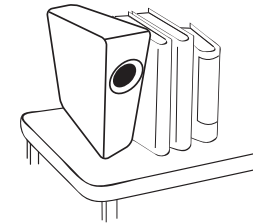

4. Do not place the projector in any of the following environments:
  - Space that is poorly ventilated or confined. Allow at least 50 cm clearance from walls and free flow of air around the projector.
  - Locations where temperatures may become excessively high, such as the inside of a car with all windows closed.
  - Locations where excessive humidity, dust, or cigarette smoke may contaminate optical components, shorten the projector's lifespan and darken the screen.

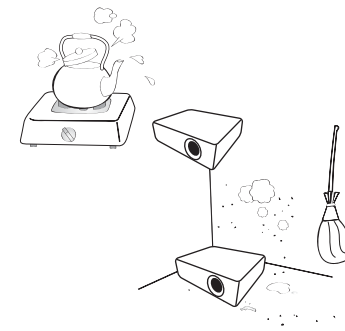

- Locations near fire alarms.
- Locations with an ambient temperature above 40°C/104°F.



- Locations where the altitudes are higher than 2000 m (6562 feet).

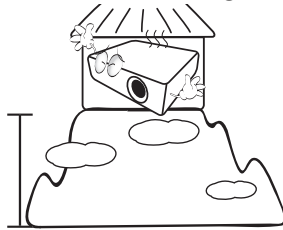

5. Do not block the vents holes while the projector is on (even in standby mode).

- Do not cover the projector with any item.
- Do not place the projector on a blanket, bedding or any other soft surface.

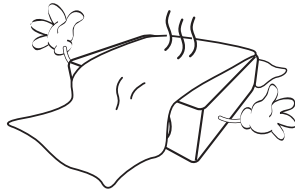

6. In areas where the mains power supply voltage may fluctuate by  $\pm 10$  volts, it is recommended that you connect the projector through a power stabilizer, surge protector or uninterruptible power supply (UPS) as appropriate to your situation.

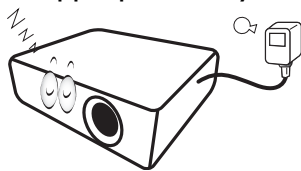

7. Do not step on the projector or place any objects upon it.

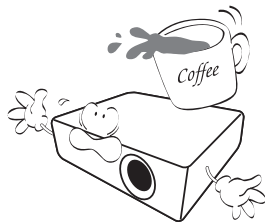

8. Do not place liquids near or on the projector. Liquids spilled into the projector will void your warranty. If the projector does become wet, disconnect it from the power point and call BenQ to have the projector repaired.

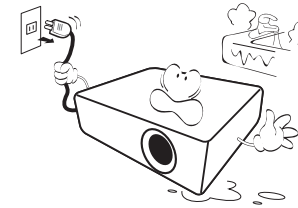

9. Do not look straight into the projector lens during operation. It may harm your sight.

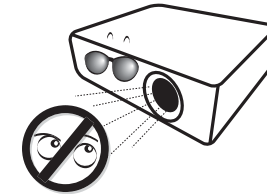

10. Do not operate the projector lamp beyond the rated lamp life. Excessive operation of lamps beyond the rated life could cause a lamp to break on rare occasions.

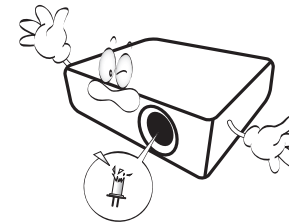

11. The lamp becomes extremely hot during operation. Allow the projector to cool for approximately 45 minutes prior to removing the lamp assembly for replacement.

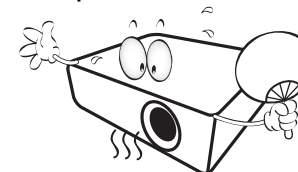

12. This projector is capable of displaying inverted images for ceiling installation.

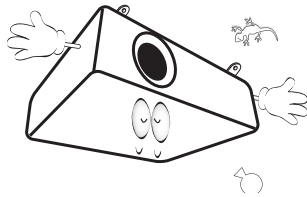

13. Do not attempt to disassemble this projector. There are dangerous high voltages inside which may cause death if you should come into contact with live parts.

Under no circumstances should you ever undo or remove any other covers. Refer servicing only to suitably qualified professional service personnel.

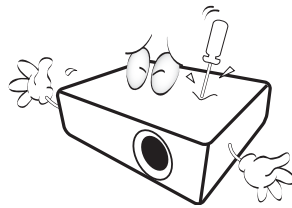

Please keep the original packing for possible future shipment. If you need to pack your projector after use, adjust the projection lens to an appropriate position, put the lens cushion around the lens, and fit the lens cushion and projector cushion together to prevent damage during transportation.

14. When you think service or repair is required, take the projector only to a suitably qualified technician.

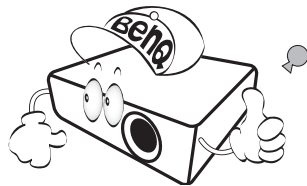

## Moisture condensation

Never operate the projector immediately after moving it from a cold location to a hot location. When the projector is exposed to such a change in temperature, moisture may condense on the crucial internal parts. To prevent the projector from possible damage, do not use the projector for at least 2 hours when there is a sudden change in temperature.

## Avoid volatile liquids

Do not use volatile liquids, such as insecticide or certain types of cleaner, near the projector. Do not have rubber or plastic products touching the projector for a long time. They will leave marks on the finish. If cleaning with a chemically treated cloth, be sure to follow the cleaning product's safety instructions.

## Disposal

This product contains the following materials which are harmful to human bodies and environment.

- Lead, which is contained in solder.
- Mercury, which is used in the lamp.

To dispose of the product or used lamps, consult your local environment authorities for regulations.



The illustrations and the images shown in this document are for your reference. The actual content may vary by the product supplied for your region.

# Package contents

Carefully unpack and verify that you have the items below. Some of the items may not be available depending on your region of purchase. Please check with your place of purchase.

## Standard accessories

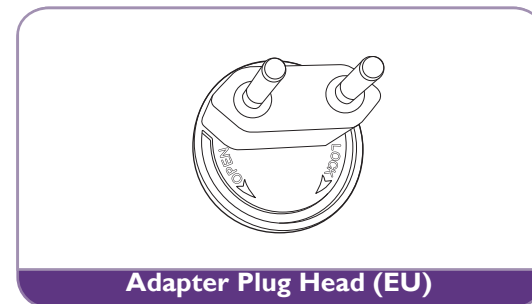
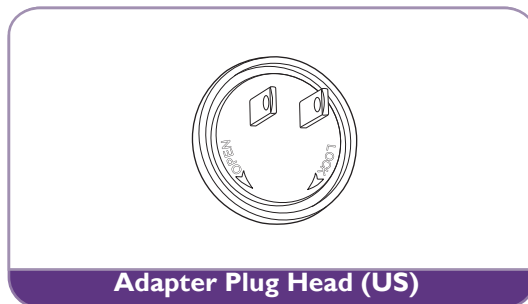
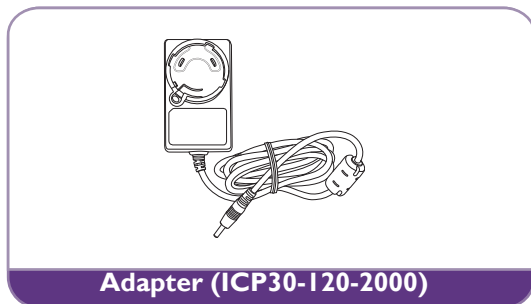
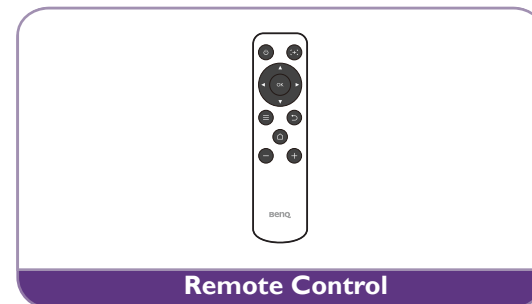
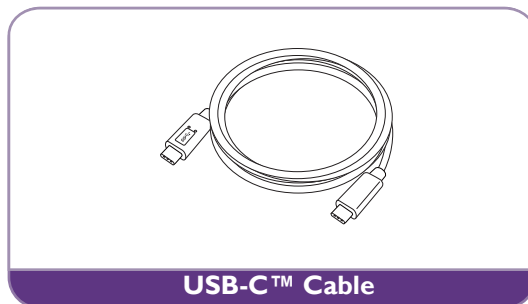

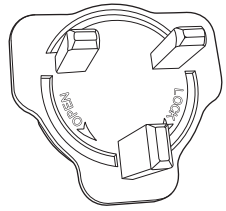

**Adapter Plug Head (UK)**

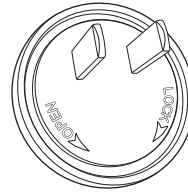

**Adapter Plug Head (CHINA)**

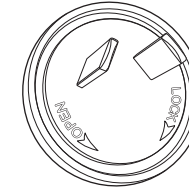

**Adapter Plug Head (AUS)**



**Carry Bag**



**Quick Start Guide**

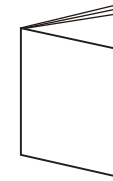

**Regulatory Statement**

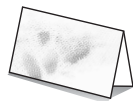

**Warranty Card**

- 
-  Lamp life results will vary depending on environmental conditions and usage. Actual product's features and specifications are subject to change without notice.
  - Some of the accessories may vary from region to region.
  - The warranty card is only supplied in some specific regions. Please consult your dealer for detailed information.
  - For AC/DC adapter, the socket-outlet shall be installed near the equipment and shall be easily accessible.
  - Use original accessories to ensure compatibility.
-

# Introduction

## Projector features

- **Instant Wireless Projection**

Release your hands and eyes to enjoy binge-watching on a big screen. If you have access to internet connection, you can cast the screen from a mobile device through GVI instantly. With GVI, you can just sit back, relax and enjoy some well-earned downtime.

- **Bluetooth® Speaker Mode**

Entertaining friends and family in style is easy with the GVI. With Bluetooth 4.0 intelligent connection, you can set GVI as a speaker, and play music from mobile device through it. Bluetooth 4.0 lets you waste less battery power because, unless critical data is being shared, the connection is solid and secure. You can connect to your devices without draining the battery.

- **Media playback from USB-C™ DisplayPort**

GVI supports laptop or mobile phone projection by USB-C™ DisplayPort interface. Once GVI is plugged into the USB-C™ DisplayPort via the USB-C™ Gen 3.1 cable, you can extend the screen for business meetings or entertainment projection.

- **Multimedia entertainment at your finger tips**

With a built-in USB reader, streaming content like movies, music and videos in a few seconds has never been simpler. You can share memorable photos or videos and everyone can enjoy them without huddling around a small screen.

- **Convenient Android-based BenQ Launcher**

The projector operates through the Android-based BenQ Launcher which is complemented by a WLAN connection that allows you to project/broadcast media via embedded or downloaded streaming apps. (The app market will be introduced by OTA update in late 2018)

- **15-Degree Adjustable Tilt for Flexible Installation**

To satisfy diverse projection scenarios, GVI introduces a considerable 15-degree adjustable tilt to avoid troublesome obstacles and ensure a perfect big screen projection.

- **Auto Keystone**

GVI offers an automatic vertical keystone adjustment function which adjusts the projected image accordingly. With 15-Degree Adjustable Tilt, you can stream content without installation hassles.

- **High Portability**

The GVI is handy and portable, making it useful for business trips and leisure activities.

- **Advanced LED light source**

The projector features a long lasting LED lightbulb that provides a longer lifespan than traditional bulbs.

- **Low Heat**

Unlike other projectors, GVI emits lower temperature, making it safe enough for inquisitive children to touch without hurting their hands.

# Projector exterior view

## Front and left side view

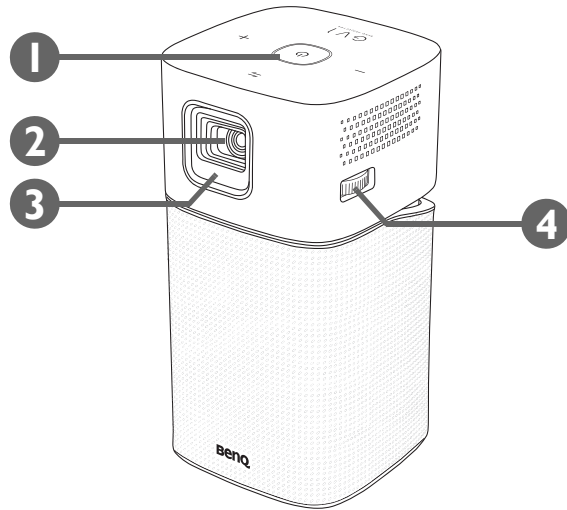

1. Control panel (See [Control panel on page 18](#) for details.)
2. Projection lens
3. Front IR sensor
4. Focus ring

## Rear and right side view

See [Connections on page 43](#) for connection details.

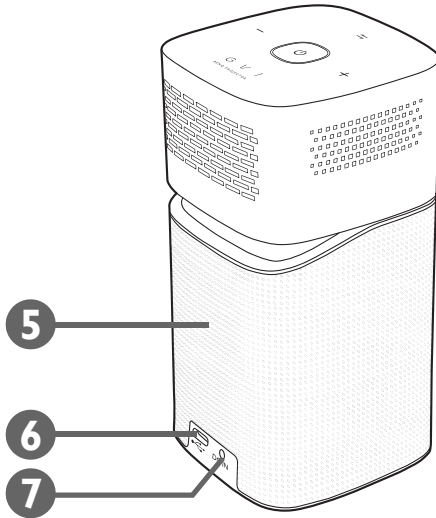

### 5. Speaker grill

Inside the speaker grill is the rear speaker.

### 6. USB-C™ port

Used to connect devices with DisplayPort functionality to project video from the device or flash drives to project/broadcast media stored on the card.

### 7. DC-IN power jack



Please only use the supplied power adapter to avoid possible dangers such as electric shock and fire.



## Bottom view

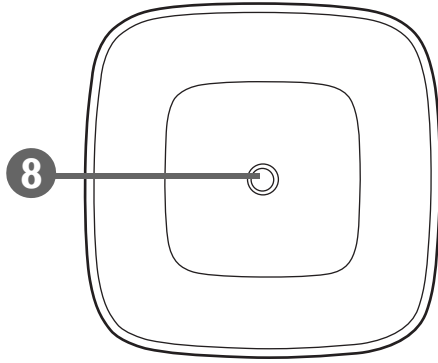

### 8. Tripod screwhole

Used to attach a tripod plate to mount the projector onto a tripod.

# Controls and functions

## Control panel

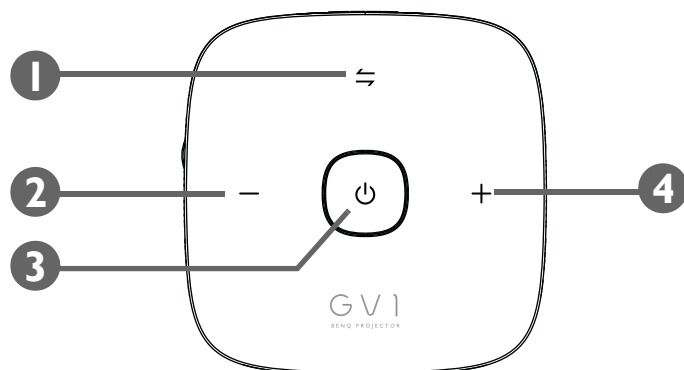

**1. ≡ Switch mode key/LED indicator**

- Toggles the Bluetooth speaker on and off.
- Acts as an LED indicator for Bluetooth and errors. See [LED Indicators on page 19](#) for more details.

**2. – Volume down key**

Decreases the projector volumes.

**3. ⏻ Power key/LED indicator**

- Turns the projector on and off. See [Starting up the projector on page 31](#) for more details.
- Acts as an LED indicator for the battery. See [LED Indicators on page 19](#) for more details.









**4. + Volume up key**

Increases the projector volume.

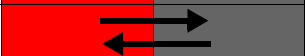
## LED Indicators

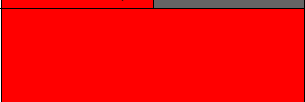
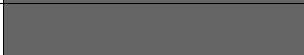
The power and switch mode keys feature LEDs that help indicate the status and possible operating errors for the projector, refer to the table below for definitions of various LED behaviors.

Scenario	Status	Power Key		Switch Mode Key	
		LED Behavior	Schema	LED Behavior	Schema
Charging with Adapter	Battery capacity < 20%	Red - breathing		N/A	
	Battery capacity = 20 - 60%	Yellow - breathing		N/A	
	Battery capacity > 60%	Green - breathing		N/A	
	Battery capacity = 100%	Green - solid		N/A	
Battery Mode	Battery capacity < 20%	Red - flashing		N/A	
	Battery capacity = 20 - 60%	Yellow - solid		N/A	
	Battery capacity > 60%	Green - solid		N/A	
Bluetooth Speaker Mode	Ready to pair / Pairing	Depends on power status		Blue - flashing	
	Pairing successful			Blue - solid	
System Update	System update in progress	Green - flashing		Blue - flashing	
	System update has failed	Red - solid		Red - solid	
	System update is successful; system is restarting	Green - solid		Blue - solid	

Scenario	Status	Power Key		Switch Mode Key	
		LED Behavior	Schema	LED Behavior	Schema
Error*	LED error	Yellow - solid		Red - flashing	
	Fan error	Red - solid		Red - flashing	
	Optical engine temperature error	N/A		Red - solid	
	Battery temperature error	N/A		Red - flashing	
	Driver board error	Red - flashing		Red - flashing	

\*If there are any errors, turn the projector off.

# Remote control

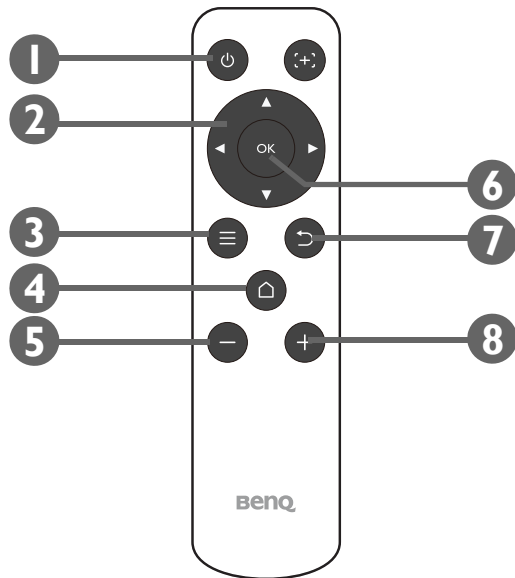

## 1. Power

Turns the projector off and on after initial startup.



After initially starting up the projector using the keypad button, the remote control power button can be used to turn the projector off or on for subsequent power ups.

See [Starting up the projector on page 31](#) for more details.

## 2. **Arrow keys (◀Left, ▶Right, ▲Up, ▼Down)**

Used as directional arrows to select the desired menu items and to make adjustments.

## 3. Settings

Launches the **BenQ Launcher** settings menu.

## 4. HOME

Press this key to enter the **BenQ Launcher** home menu



This key is only active when the projector is under **BenQ Launcher** mode.

## 5. **- Volume Down**

Decreases the projector volume.

## 6. **OK**

Used to confirm the selection on the **BenQ Launcher** menu.

## 7. BACK

Used to return to the previous layer.

## 8. **+ Volume Up**

Increases the projector volume.

## Activating the remote control battery

Before you can begin to use the remote control, you must first remove the clear plastic battery sticker between the battery and the contact on the remote control.

1. Use a flat-tipped instrument to rotate the battery cover counter-clockwise to the unlocked position.

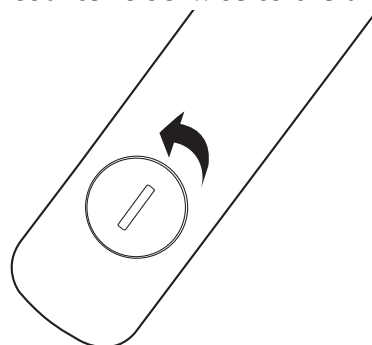

2. Remove the battery cover from the remote control.
3. Pull and remove the plastic battery sticker.

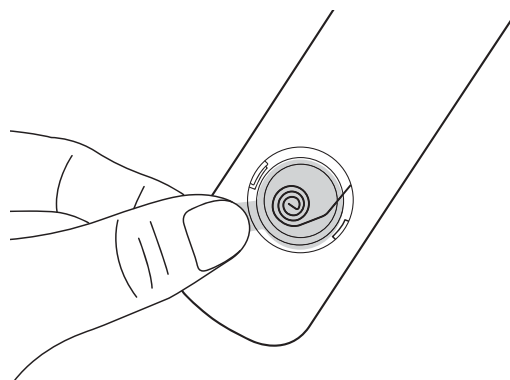

4. Place the battery cover back onto the remote control and rotate it clockwise to the locked position.

---

 Avoid leaving the remote control and battery in an excessive heat or humid environment like the kitchen, bathroom, sauna, sunroom or in a closed car.

---

## Replacing the remote control battery

1. Use a flat-tipped instrument to rotate the battery cover counter-clockwise to the unlocked position.

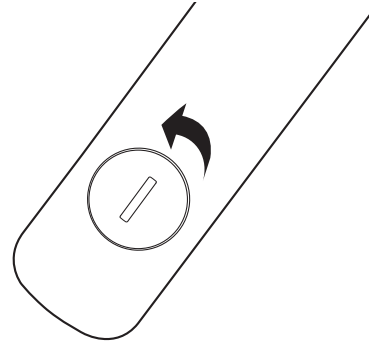

2. Remove the battery cover from the remote control.
3. Carefully dislodge the used battery from underneath the retention coil and slide it out from the remote control.

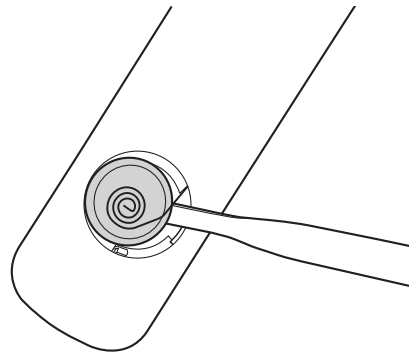

4. Slide the new battery into its position underneath the retention coil.
5. Place the battery cover back onto the remote control and rotate it clockwise to the locked position.

- 
- Avoid leaving the remote control and battery in an excessive heat or humid environment like the kitchen, bathroom, sauna, sunroom or in a closed car.
  - Replace only with the same or equivalent type recommended by the battery manufacturer.
  - Dispose of the used batteries according to the manufacturer's instructions and local environment regulations for your region.
  - Never throw the battery into a fire. There may be danger of an explosion.
-

## Remote control effective range

The projector's IR remote control sensor is located at the front of the projector with a range of 8 metres (~26 feet) at an angle of 30-degrees (left and right) and 20-degrees (up and down). The remote control can be used either by pointing it at the front of the projector or by reflecting the IR signal off of a wall.

Make sure that there are no obstacles between the remote control and the IR sensor on the projector.

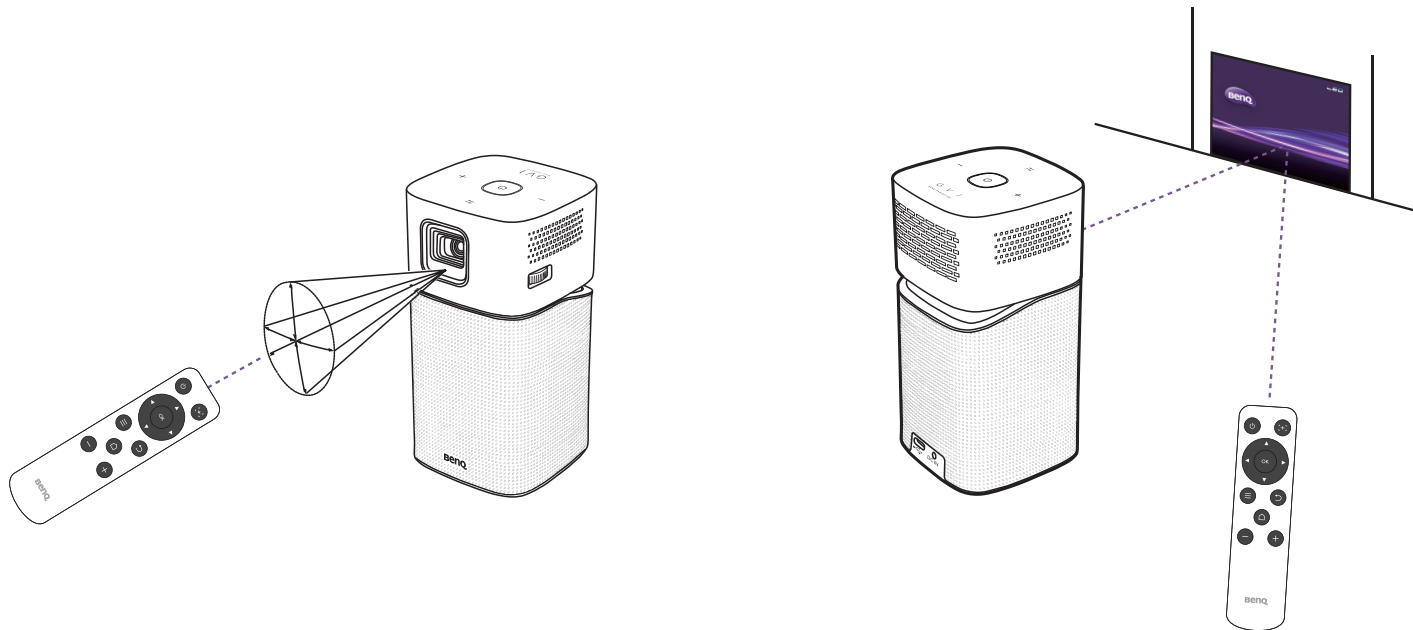





# Installation

## Choosing a location

Before choosing an installation location for your projector, take the following factors into consideration:

- Size and position of your screen
- Electrical outlet location
- Location and distance between the projector and the rest of your equipment
- Location and distance between the projector and the wireless access point, or if using a LAN cable, the internet hub

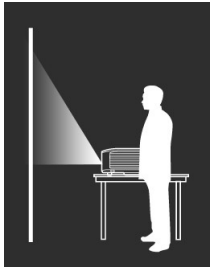
You can install your projector in the following ways.

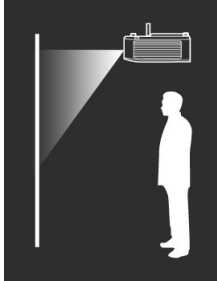
<p><b>1. Front Table:</b></p> <p>Select this location with the projector placed near the floor in front of the screen.</p> <p>This is the most common way to position the projector for quick setup and portability.</p> <p>Turn on the projector and select the following settings:</p> <p><b>Settings &gt; Installation &gt; Projector Installation &gt; Front Table</b></p>	 A silhouette diagram showing a person sitting at a table. A projector is placed on the table, projecting a beam of light onto a vertical screen to the left.
<p><b>2. Front Ceiling:</b></p> <p>Select this location with the projector elevated near the ceiling in front of the screen.</p> <p>Turn on the projector and select the following settings:</p> <p><b>Settings &gt; Installation &gt; Projector Installation &gt; Front Ceiling</b></p> <p> The projector does not feature ceiling mount components/equipment so when choosing to use a front ceiling location you must place it on an elevated location of your choice.</p>	 A silhouette diagram showing a person standing. A projector is mounted on the ceiling, projecting a beam of light onto a vertical screen to the left.

### 3. Rear Table:

Select this location with the projector placed near the floor behind the screen.

Turn on the projector and select the following settings:

**Settings > Installation > Projector Installation > Rear Table**



A special rear projection screen is required.

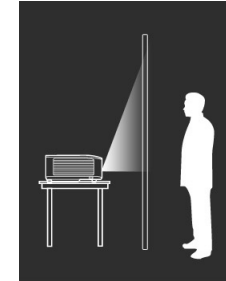

### 4. Rear Ceiling:

Select this location with the projector elevated from the ceiling behind the screen.

Turn on the projector and select the following settings:

**Settings > Installation > Projector Installation > Rear Ceiling**



A special rear projection screen is required.



The projector does not feature ceiling mount components/equipment so when choosing to use a rear ceiling location you must place it on an elevated location of your choice.

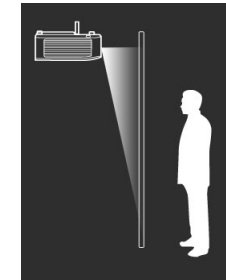

## Obtaining a preferred projected image size

The projected image size is determined by the distance from the projector lens to the screen, and the video format. The data in the table below is based on a normal projection method and not the result of adjusting the projection angle (1-15 degrees).

### Projection dimensions

Use the illustration and tables below to help you determine the projection distance.

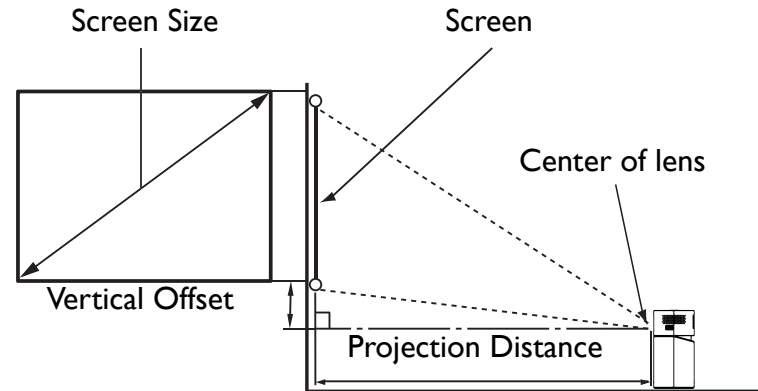

Screen size			Projector distance (mm)	
Diagonal		H (mm)	W (mm)	Average
Inch	mm			
30	762	664	373	864
35	889	775	436	1007
40	1016	886	498	1151
45	1143	996	560	1295
50	1270	1107	622	1439
55	1397	1218	684	1583

Screen size			Projector distance (mm)	
Diagonal		H (mm)	W (mm)	Average
Inch	mm			
60	1524	1329	747	1727
65	1651	1439	809	1871
70	1778	1550	871	2015
75	1905	1661	933	2159
80	2032	1771	996	2303
85	2159	1882	1058	2447
90	2286	1993	1120	2591
95	2413	2104	1182	2735
100	2540	2214	1245	2879

 All measurements are approximate and may vary from the actual sizes. If you want a permanent installation of the projector, we recommend that you use the actual projector to physically test the projection size, distance, and the projector's optical characteristics prior to the installation. This helps you determine the exact mounting position which best suits your installation.

# Operations

## Attaching the plug head

1. Place the plug head onto the adapter.
2. Rotate the plug head clockwise until it clicks into place.

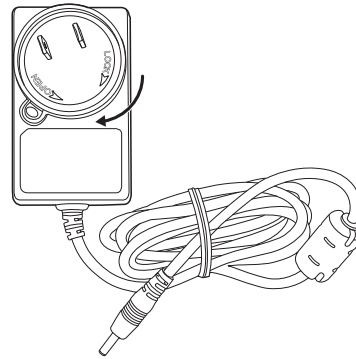

## Removing the plug head

1. Press the button next to the plug head on the adapter.
2. Rotate the plug head counter-clockwise and remove the plug head from the adapter.

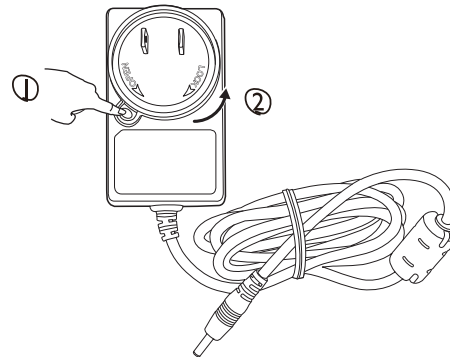

---

 Images above may differ depending on the region of the plug head.

---

## Charging the battery

1. Charge the projector's battery by leaving the supplied power adapter connected to the projector and a power outlet.

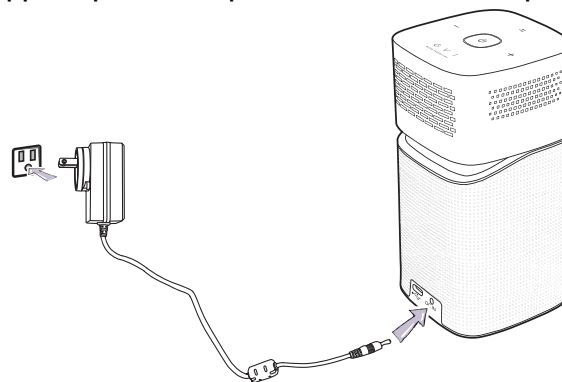

- The power LED indicator will illuminate according to its charge status, for a full charge wait until the indicator lights up solid green (see [LED Indicators on page 19](#) for more information on LED behavior).

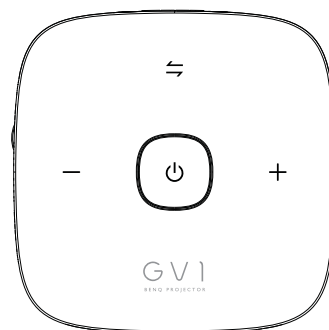

---

 **Charge the battery fully to ensure successful OTA update.**

---

## Starting up the projector

1. Charge the battery or supply power to the projector by plugging the supplied power adapter into the projector and a power outlet.
2. Press and hold the power key  for 3 seconds. The power LED indicator on the projector lights up and “breathes” blue after power has been applied. It will then illuminate according to its charge setting (see [LED Indicators on page 19](#)).

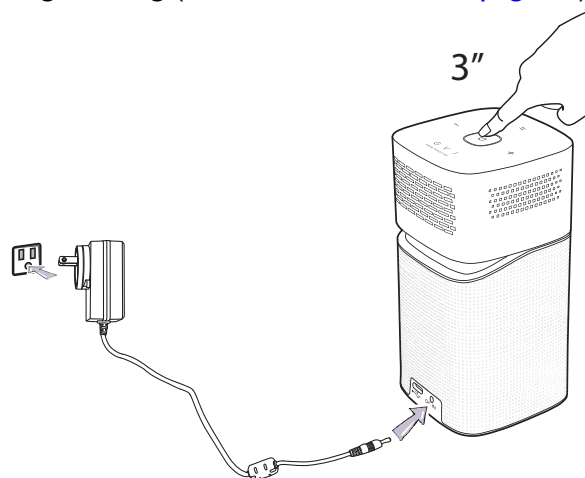





- 
- The power button on the remote control is not able to power on the projector, powering on the projector can only be done using the power key on the top side of the projector.
  - When supplying power directly to the projector please use the supplied power cable to avoid possible dangers such as electric shock and fire.
- 

3. Connect any video equipment supporting DisplayPort (version 1.1 or above) or a USB-C™ storage device to the USB-C™ port on the rear of the projector. If you want to project video via a wireless connection or if you want to access the **BenQ Launcher**, you do not need to connect any video equipment.
- 

 For more details on connection options, see [Connections on page 43](#).

---

4. The fans start operating, and a start-up image will be shown while the projector warms up, this process may take a few minutes. The projector does not respond to further commands while it is warming up.
5. If this is the first time you turn on the projector, the setup wizard appears to guide you through setting up the projector. If you have already done this, skip this step.
  - Use the arrow keys (, , , ) on your remote control to move through the menu items.

- Use **OK** to confirm the selected menu item.
- Use **Back** to return to the previous menu.
- Use **MENU** to skip a menu.

 The Setup Wizard screenshots below are for reference only and may differ from the actual design.

Step 1:

Specify **Language**.



 Available languages may vary by the product supplied for your region and may be updated without prior notice.



Step 2:

Configure the Wi-Fi settings by selecting the Wi-Fi network and entering the password.

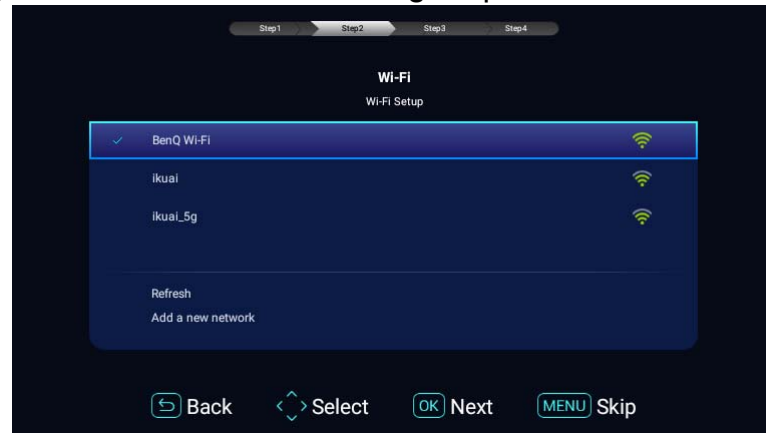

To connect to a hidden Wi-Fi network select **Add a New Network** and enter the SSID, security setting, and password for the network.

Step 3:  
Specify **Time Zone**.

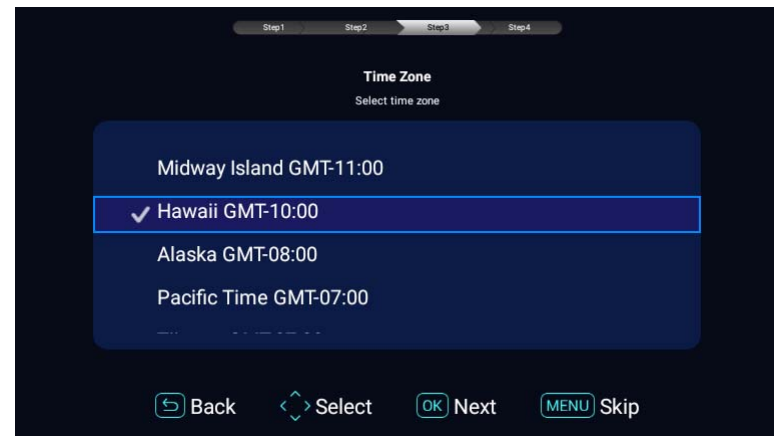

Step 4:  
Read the **Privacy Announcement** and press **OK**.

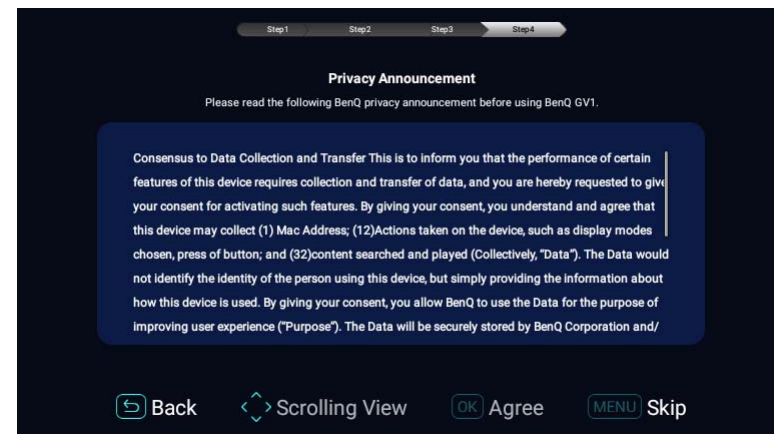

You've completed the setup wizard, you may now connect a device to the projector to project video, see [Connections on page 43](#) for more information.

## Shutting down the projector

1. Press  on the projector or your remote control. The projector displays a shutdown confirmation message.
2. The power LED indicator turns off and will illuminate again according to its charge status if the adapter is connected to the projector (see [LED Indicators on page 19](#)). The fans may continue to run in order to cool the lamp.

If the projector will not be used for an extended period, unplug the power cable from the power outlet.

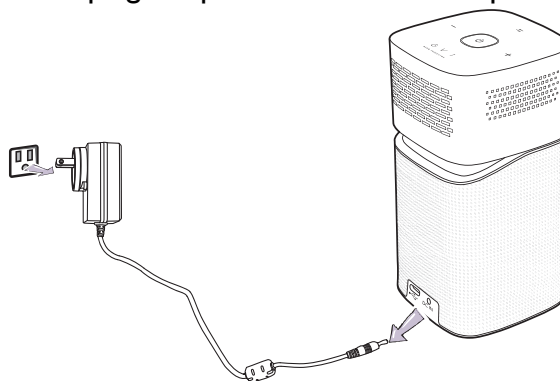

- Avoid turning on the projector immediately after turning it off as excessive heat may shorten lamp life.
- The actual lamp life may vary due to different environmental conditions and usage.

# Adjusting the projected image

## Adjusting the projection angle

The projector is equipped with a pivoting head which changes the image height and projection angle.

To adjust the projection angle:

- Pivot the head upwards or downwards until the image is positioned as desired.

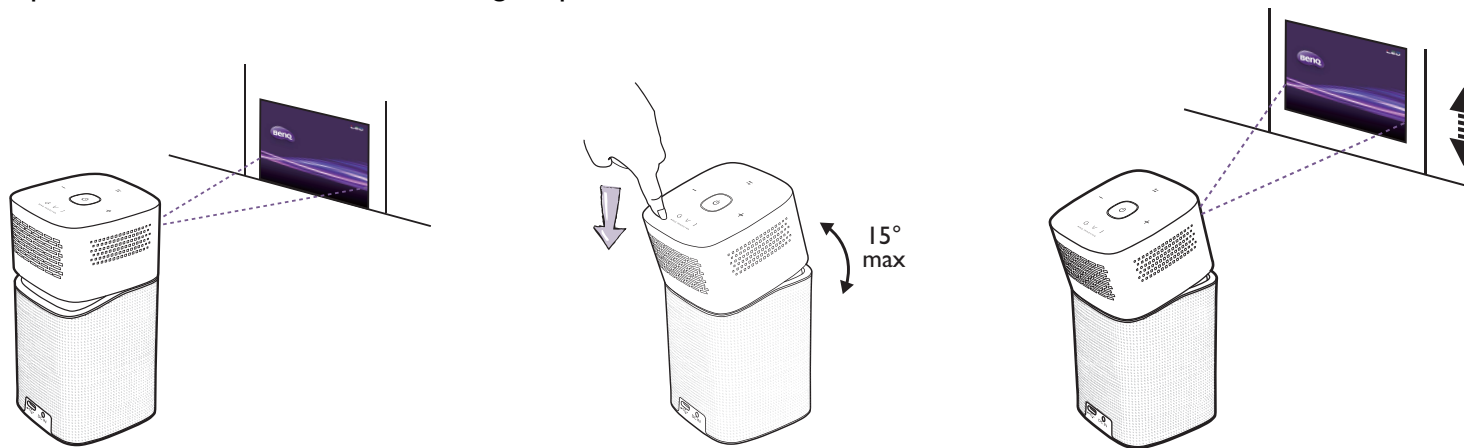

- The maximum angle of adjustment is 15 degrees.
- If the screen and the projector are not perpendicular to each other, the projected image becomes vertical trapezoidal. To correct this, see [Correcting keystone on page 38](#) for details.

## Fine-tuning the image clarity

To sharpen the picture, rotate the focus ring on the side of the projector.

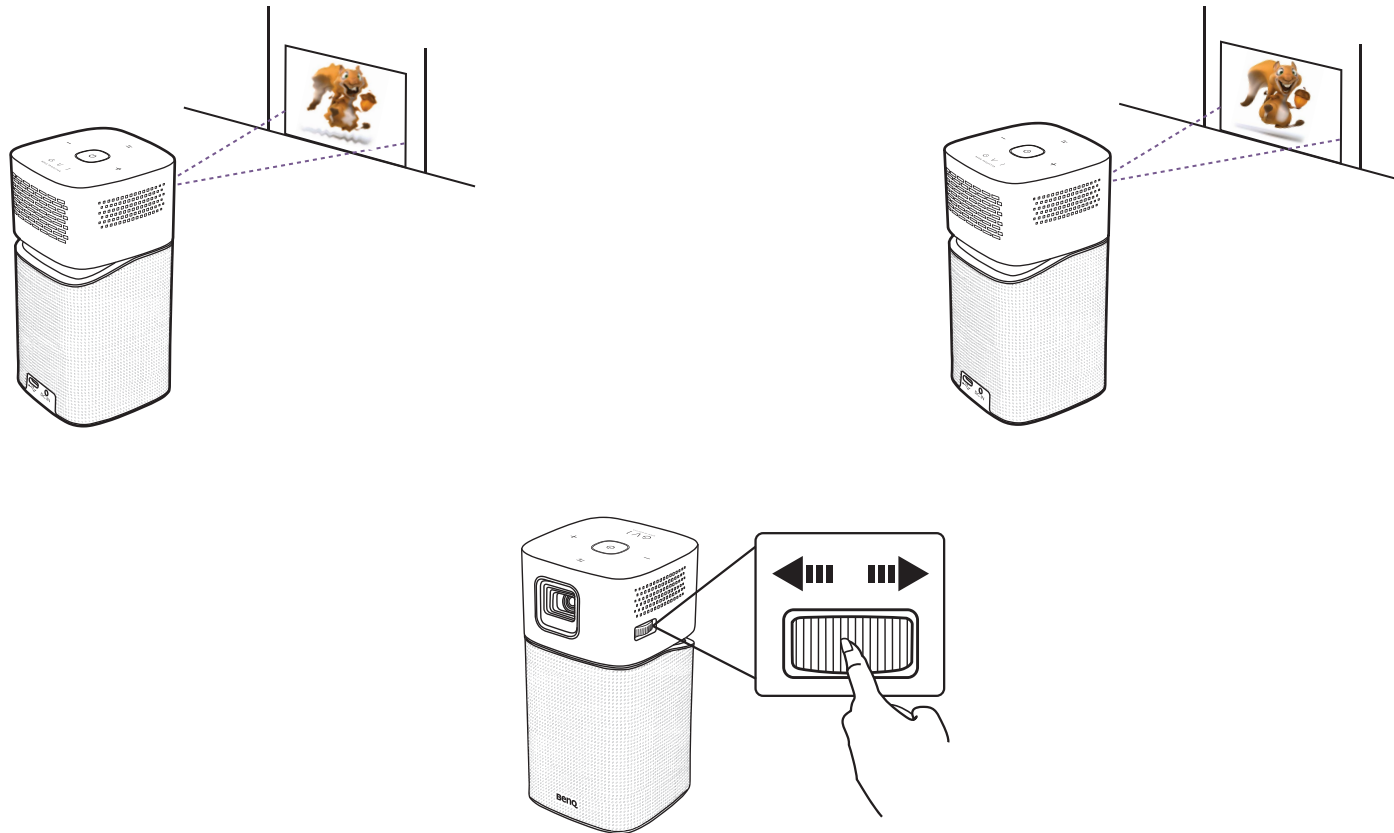

---

**!** Do not look into the lens while the lamp is on. The strong light from the lamp may cause damage to your eyes.

---

## Correcting keystone

Keystoning refers to the situation where the projected image is noticeably wider at either the top or bottom. It occurs when the projector is not perpendicular to the screen.

To adjust the **Keystone**:

1. Press the down arrow key ▼ on the remote control to navigate to the settings menus.
2. Select **Settings** and press **OK**.
3. Select **Installation** and press **OK**.
4. Disable the **Auto Keystone** setting.
5. Select **Keystone** and press **OK**.

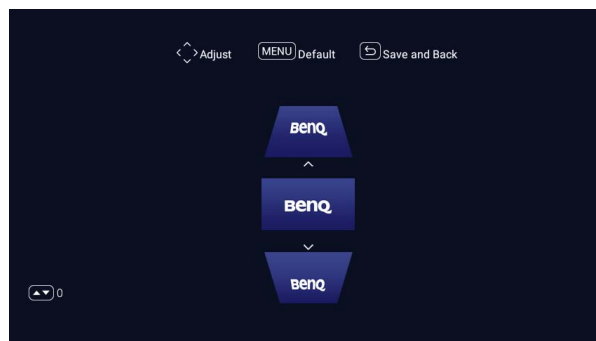
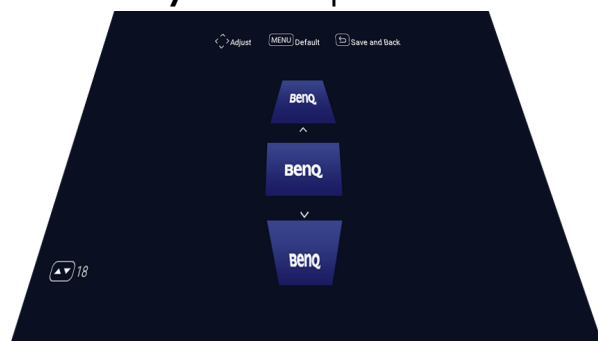

- To correct keystone at the top of the image, use ▲ on your remote control.
- To correct keystone at the bottom of the image, use ▼ on your remote control.
- To return to default keystone settings press the menu button on your remote control



You may only make these adjustments if **Auto Keystone** is disabled in the Installation menu, see [Installation on page 83](#) for details.

6. When you are done adjusting the keystone, press ⇨ to save your changes and return to the previous menu, or press ⇩ to save your changes and go back to the home screen directly.

# BenQ Launcher



**BenQ Launcher** is the projector's operating system that allows you to project videos wirelessly or play media files, as well as adjust projector settings.

 Use your remote control to operate **BenQ Launcher** functions. The projector's control panel keys are limited to control projector functions.

## The BenQ Launcher home page

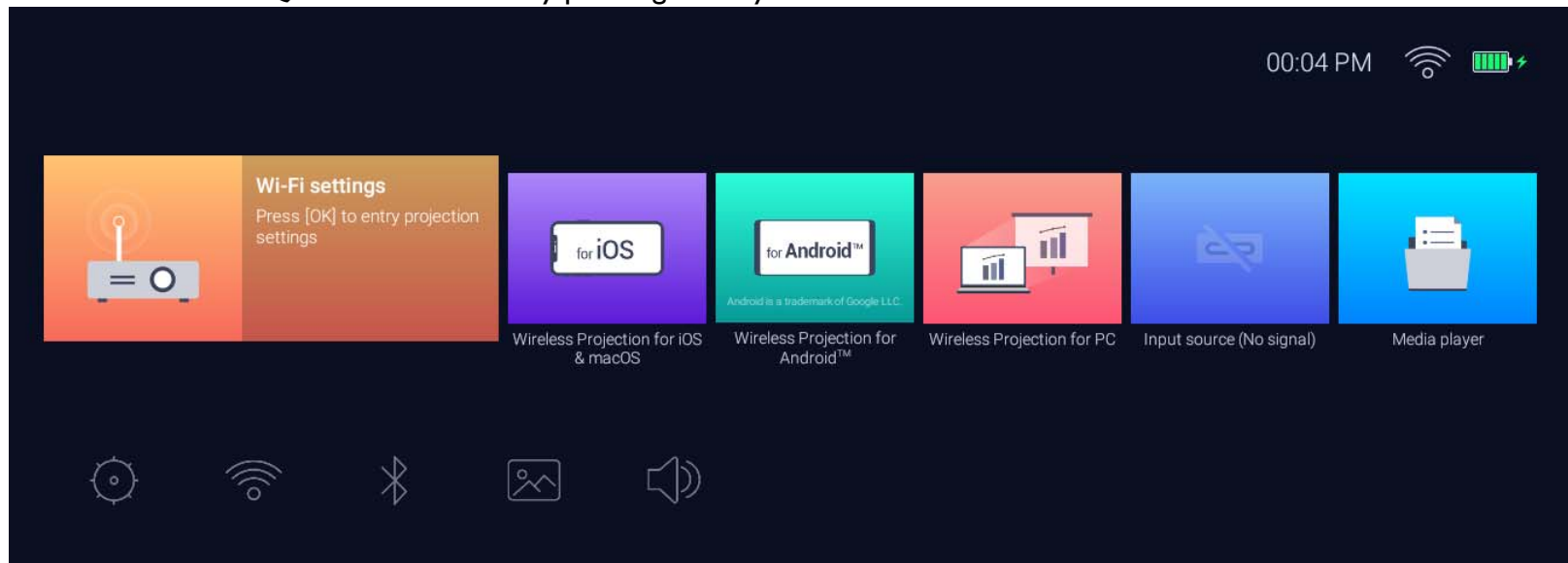
When the projector is not projecting an image from a connected source it will display **BenQ Launcher** by default. If the projector is projecting from a source, you can return to **BenQ Launcher** mode by pressing  on your remote control.



-  • Actual screen may vary based on your BenQ Launcher firmware version.
-  • **Keep at least 60% of battery (3 bars on the battery status icon) to ensure successful OTA update.**

The **BenQ Launcher** home page features five main sections:

- **Wireless Projection buttons** - Provides instructions on how to project wirelessly via iOS/Android devices or a laptop/PC.
  - **Input Source buttons** - Projects the current device connected via USB-C™.
- 



Only devices with DisplayPort (version 1.1 or above) functionality can project via the USB-C™ connection.

---

- **Media Player buttons** - Plays the media files from a device connected via USB-C™.
  - **Status Bar icons** - Icons that display the date, time, wireless and battery status.
  - **Settings menus** - Shortcuts to the settings menus to adjust Wi-Fi, Bluetooth and other settings.
- 



Press the down button ▼ on the remote control to access the **Settings** menus.

---

## Navigating the **BenQ Launcher** home page

1. From the **BenQ Launcher** home page, press ◀/▶/▲/▼ on your remote control to select the desired function and press **OK**.
2. Follow on-screen instructions for further operations.



## Using the **BenQ Launcher Settings** menus

Press the down button ▼ on the remote control from the **BenQ Launcher** home page to access the settings menu section, which features a button for the projector's full settings menu as well as shortcut buttons for various sub-menus within the settings menus.

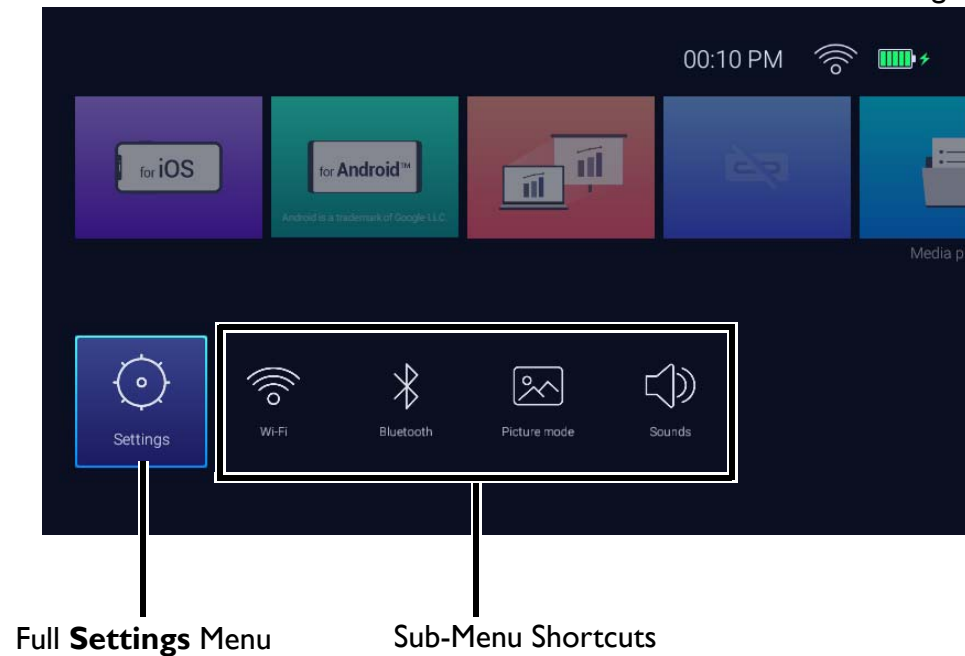

---

 Actual screen may vary based on your BenQ Launcher firmware version.

---

For more information on the settings menus see [About the Settings menu on page 75](#).

## Inputting text

Various menus within the **BenQ Launcher** may require that you input text. To input text in a text field:

1. Select the text field where you want to input text.
2. Press **OK** on your remote control, a full alphanumeric keyboard will appear on screen.

3. Press ◀/▶/▲/▼ on your remote control to navigate the keyboard, and press **OK** to select the letter/key/symbol you want to enter into the text field.
4. Press ⇨ at anytime to exit out of the keyboard.

# Connections

You can connect your device to the projector in various ways to project video content.

## Wireless Connection (Wi-Fi)

- Smartphone, Tablet, Laptop/PC.

## Wired Connection (USB-C™ port)

- Smartphone, Tablet, Laptop/PC

- 
-  • Devices connected via the USB-C™ port require a USB-C™ cable and must support DisplayPort (version 1.1 or above) functionality in order to project video.
  - When the projector is running on battery power (not connected to a power source), it will not charge or provide power to any devices connected to the USB-C™ port. Only when the projector is connected to a power source will it be able to charge or provide power to devices connected to the USB-C™ port.
- 

- USB-C™ flash drive

Furthermore, you can also connect the projector to Bluetooth speakers/headphones to broadcast audio through the speakers/headphones or connect a mobile device to the projector via Bluetooth to broadcast audio through the projector's speakers.

Before connecting a signal source to the projector, be sure to:

- Place the projector within range of the wireless AP you plan to connect it to.
- Use the correct signal cables for each source.
- Make sure the cables are firmly inserted.

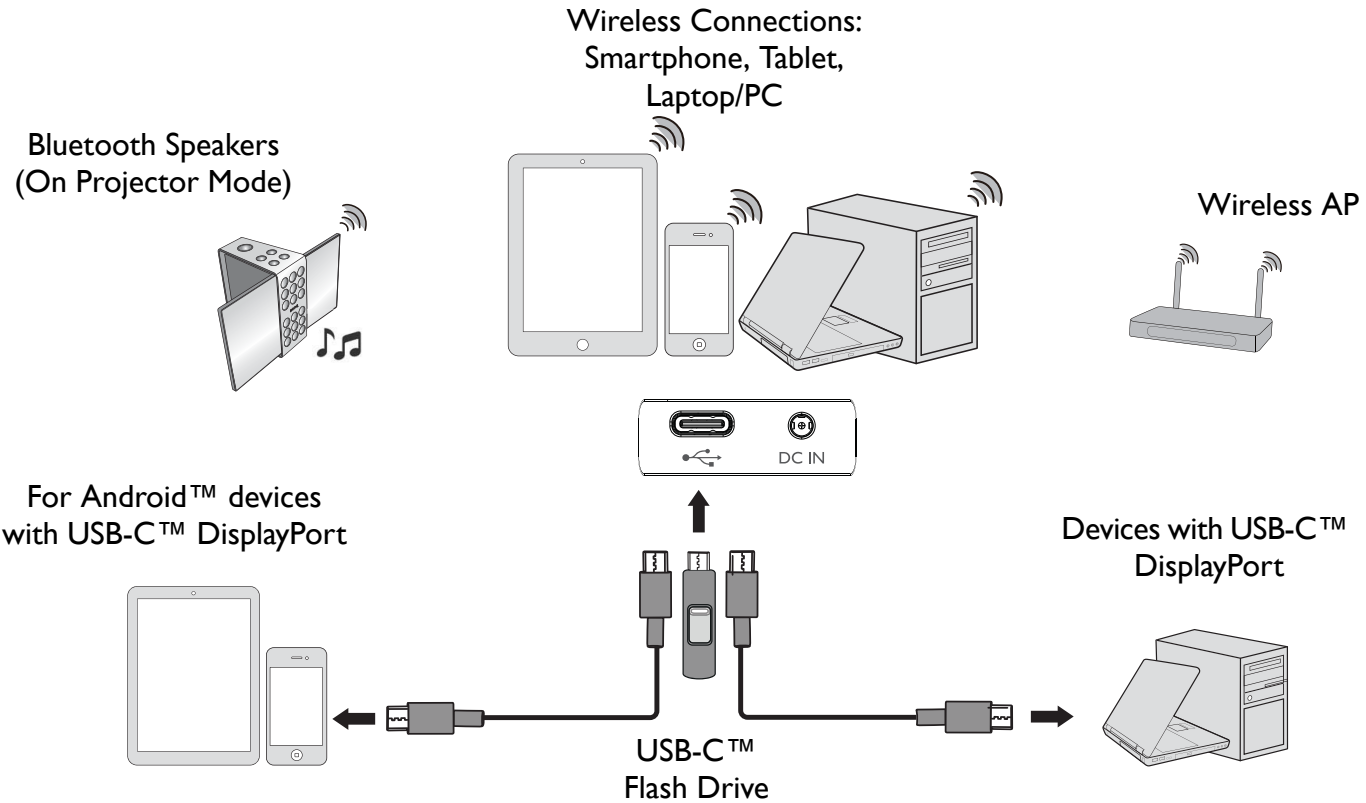

---

 The illustration above is for reference only.

---

# Wireless Connections

## Connecting the projector to a Wi-Fi network

Before you can project wirelessly via the projector you must first connect the projector to a Wi-Fi network. To connect your projector to a Wi-Fi network, or to switch Wi-Fi networks:



If you have already connected the projector to a Wi-Fi network during the setup wizard you may skip the steps in this section.

1. Power on the projector (see [Starting up the projector on page 31](#)).
2. On the home page of the **BenQ Launcher** interface, press the down arrow key ▼ on the remote control to navigate to the settings menus.
3. Select **Wi-Fi** in the settings menus and press **OK**.

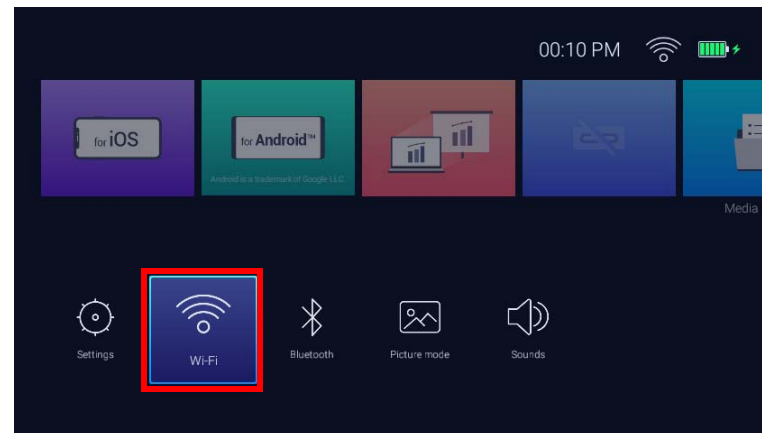

4. Select **Wi-Fi** and press **OK** to enable Wi-Fi.

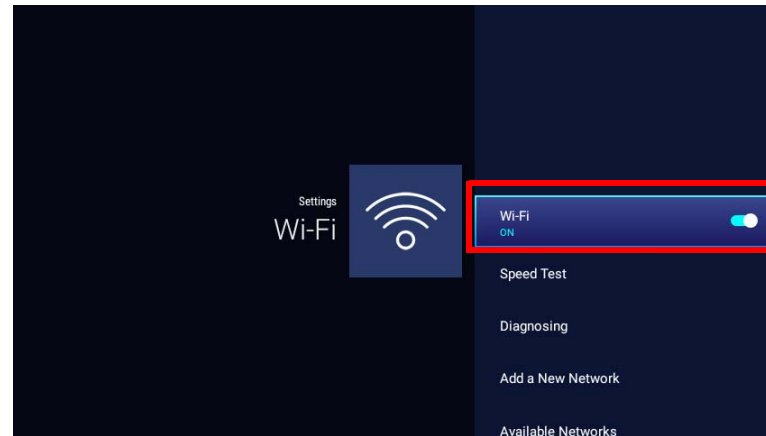

5. Select the SSID for the wireless AP you want to connect to.

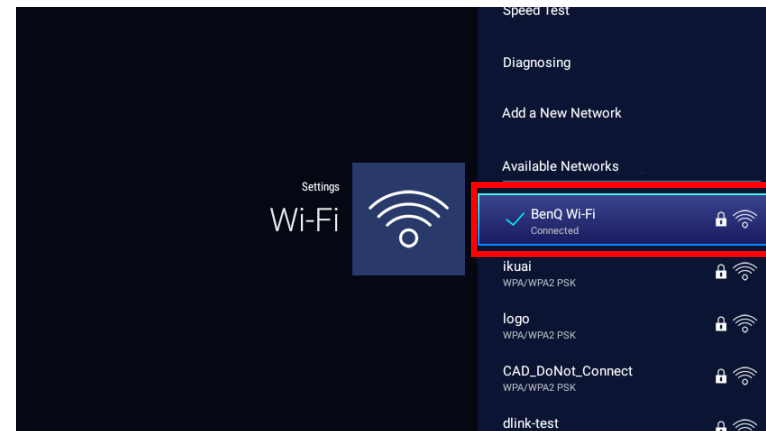

- To connect to a hidden Wi-Fi network select **Add a New Network** and enter the SSID, security setting, and password for the network.
- The list of available Wi-Fi networks will be refreshed every 10 seconds. If the desired SSID is not listed please wait for refreshing to complete.

6. If you chose a secured SSID for the first time, a window appears prompting you to enter the appropriate password. Use the virtual keypad to enter the password. After you have entered the password, select **Next** and the projector will automatically connect.



- The password will be stored in the projector's memory. In the future, if you select the same SSID again, you will not be prompted to enter a password unless you delete the SSID from the projector's memory.
- If the password is typed incorrectly, you can select either **Try Again** to return to the virtual keypad or **View Available Networks** to return to the list of SSIDs.

7. Once you have successfully connected to the wireless AP a wireless connection icon will appear at the top right corner of the **BenQ Launcher** interface. You can now connect your devices wirelessly to the projector to project videos.

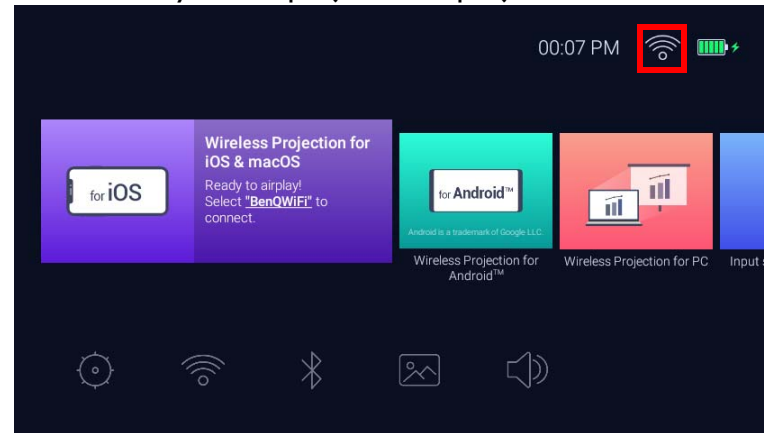

## Wireless Projection for iOS & macOS®

To connect an iOS device to the projector and project video via AirPlay:

1. On the home page of the **BenQ Launcher** interface, select **Wireless Projection for iOS & macOS** and press **OK**.

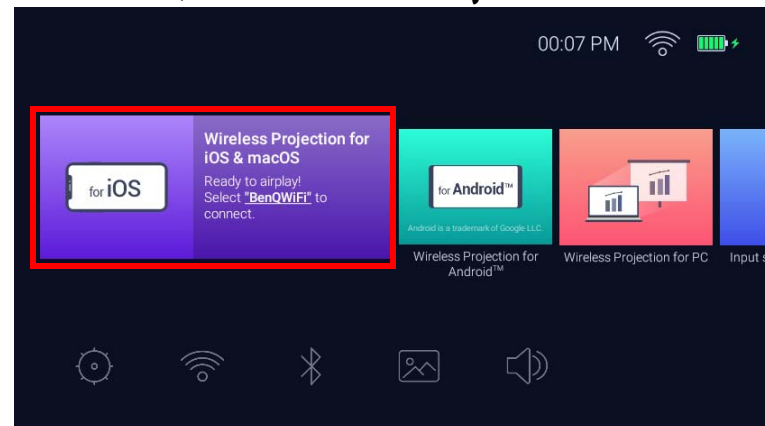

2. On your iOS mobile device's Wi-Fi menu connect to the Wi-Fi network shown on the **Wireless Projection for iOS & macOS** screen and then select **Next**.

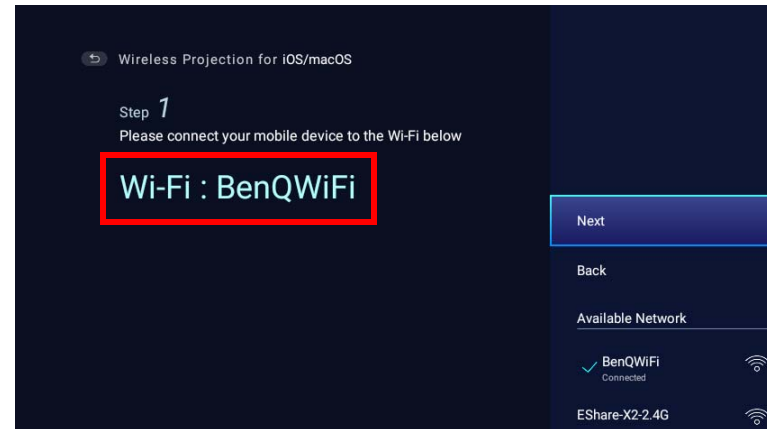

3. Follow the instructions shown on the **Wireless Projection for iOS & macOS** screen to project your iOS device's screen via AirPlay.

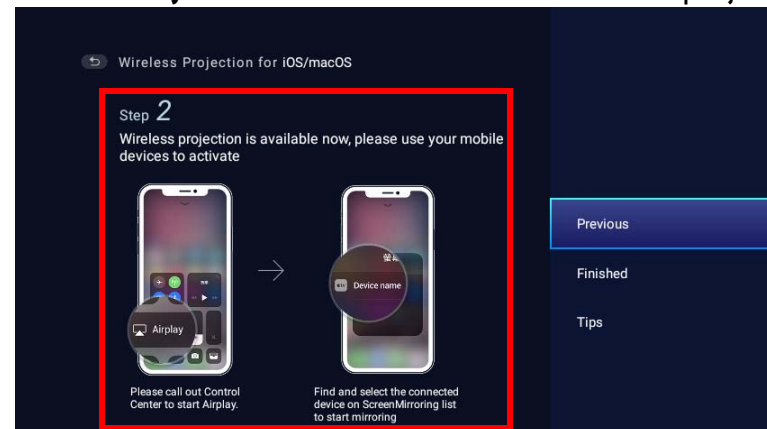



4. Select **Finished** on the **Wireless Projection for iOS & macOS** menu to finish the tutorial and return to the home screen.

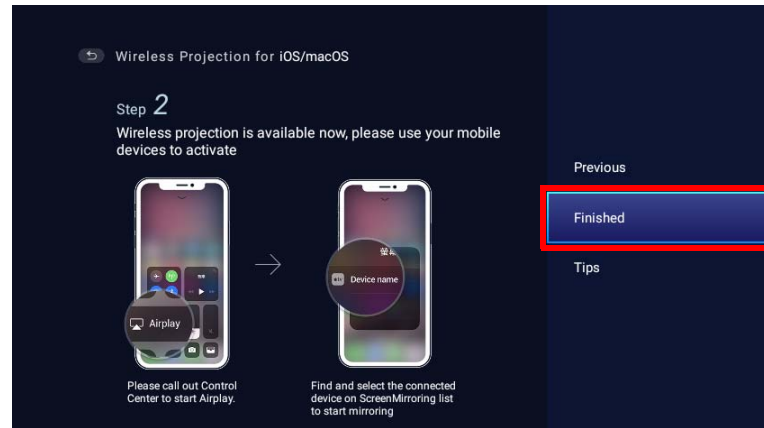

Once you have finished projecting, disable AirPlay on your iOS device to end the connection.

## Wireless Projection for Android™

To connect an Android™ device to the projector and project video:

1. On the home page of the **BenQ Launcher** interface, select **Wireless Projection for Android™** and press **OK**.

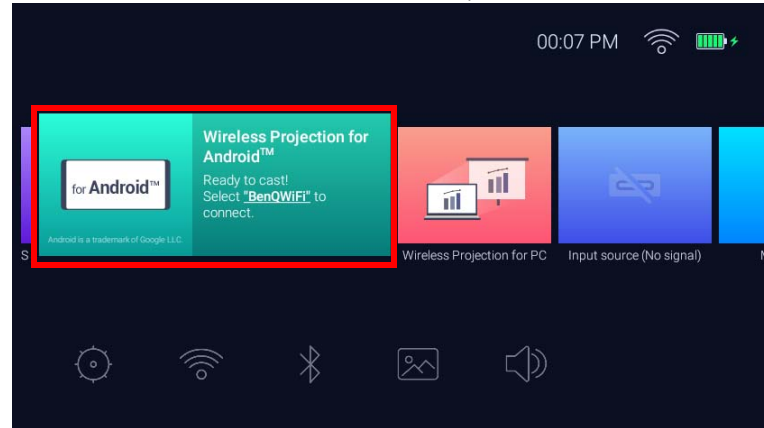

2. On your Android mobile device's Wi-Fi menu connect to the Wi-Fi network shown on the **Wireless Projection for Android™** screen and then select **Next**.

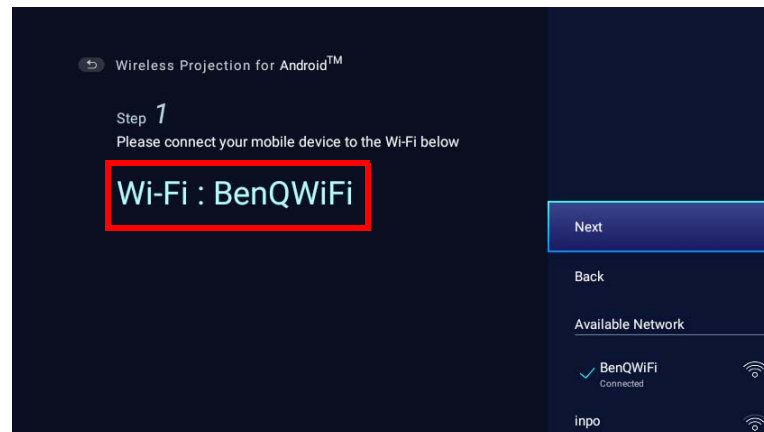

3. Follow the instructions shown on the **Wireless Projection for Android™** screen to project your Android device's screen.

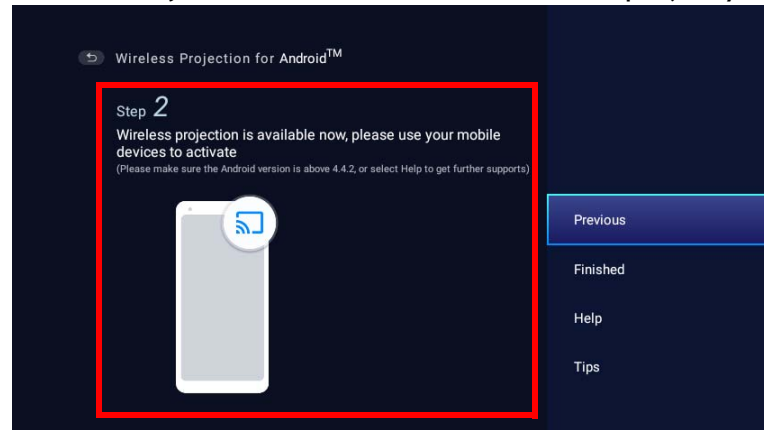

4. Select **Finished** on the **Wireless Projection for Android™** screen to finish the tutorial and return to the home screen.

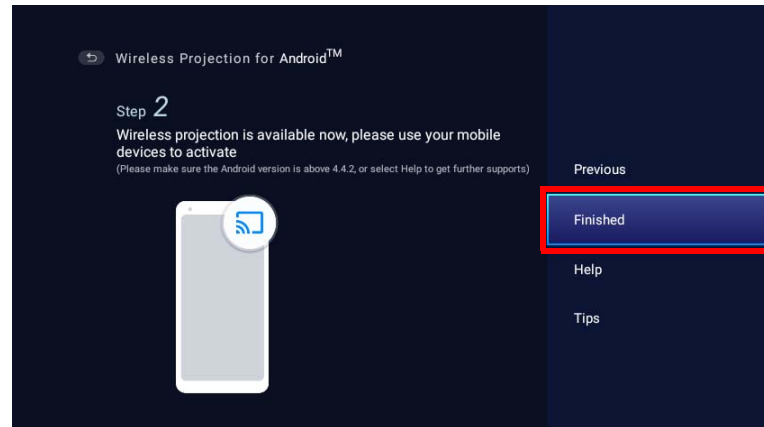

Once you have finished projecting, disable screencasting on your Android device to end the connection.

## Wireless Projection for PC

To connect a PC to the projector and project video:

1. On the home page of the **BenQ Launcher** interface, select **Wireless Projection for PC** and press **OK**.

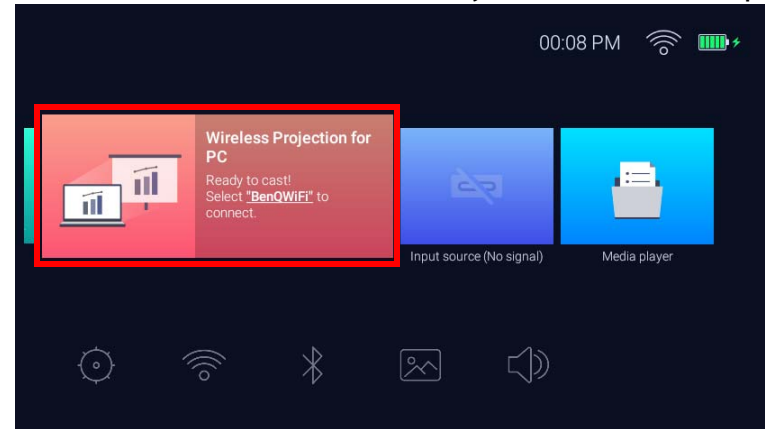

2. On your PC's Wi-Fi menu connect to the Wi-Fi network shown on the **Wireless Projection for PC** screen and then select **Next**.

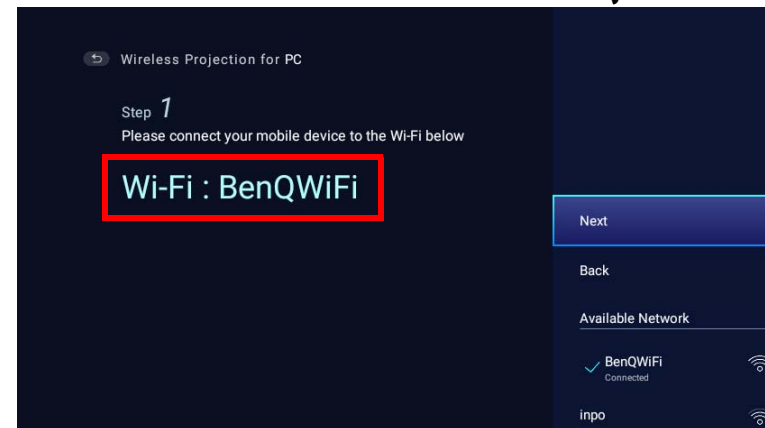

3. Follow the instructions shown on the **Wireless Projection for PC** screen to project your PC's screen.

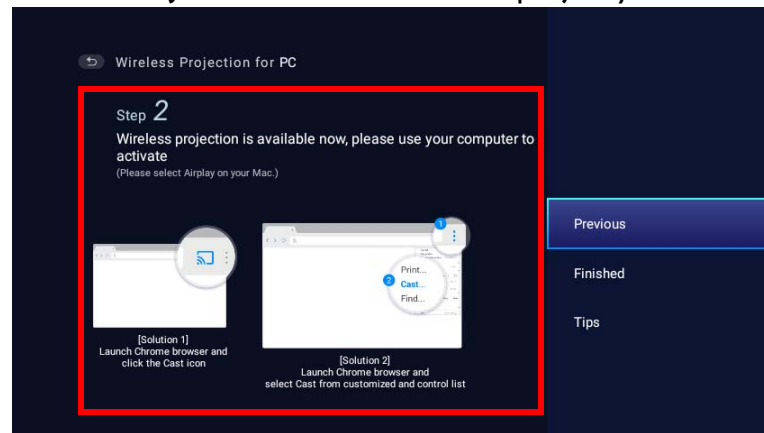

4. Select **Finished** on the **Wireless Projection for PC** screen to finish the tutorial and return to the home screen.

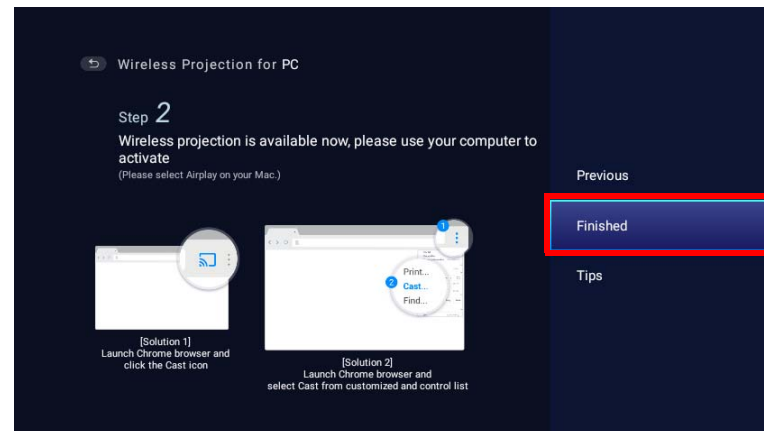

Once you have finished projecting, disable screencasting on your PC to end the connection.

# Wi-Fi Hotspot

In situations where the projector is out-of-range of a Wi-Fi network (for example while on a camping trip), you can configure the projector to act as a Wi-Fi hotspot to create a closed network for devices to connect directly to the projector via a wireless connection and to project files from their local storage.

---

 The projector will have no access to the Internet while in Wi-Fi hotspot mode.

---

To create a Wi-Fi hotspot:

1. On the home page of the **BenQ Launcher** interface, press the down arrow key ▼ on the remote control to navigate to the settings menus.
2. Select **Settings** and press **OK**.

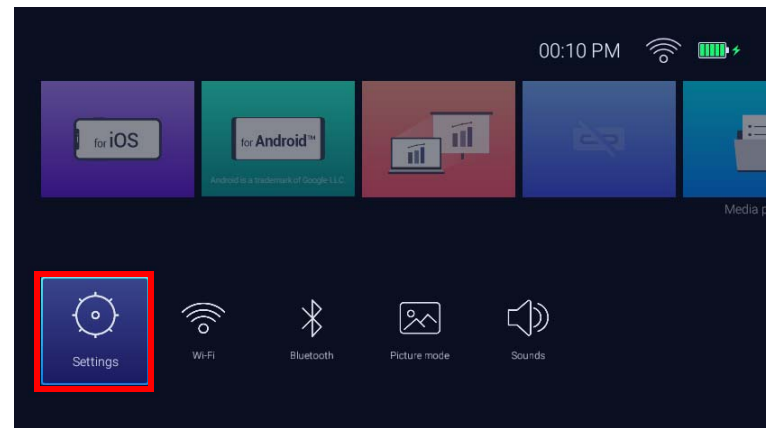

3. Select **Hotspot** and press **OK**.

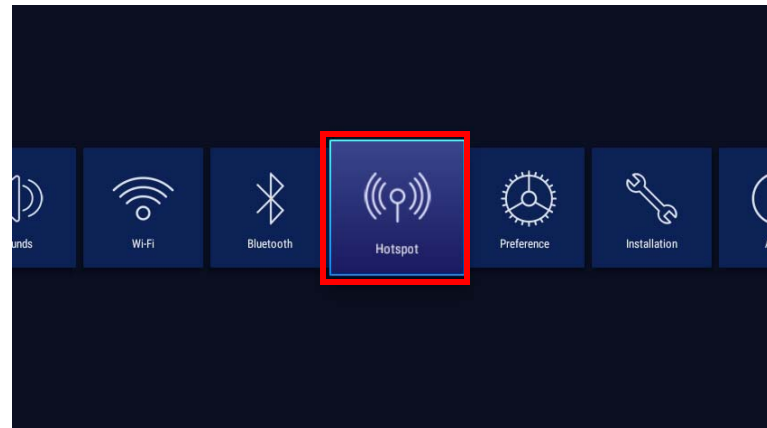

4. (Optional) Select **Hotspot Password** and press **OK** to change the password of the Wi-Fi hotspot.

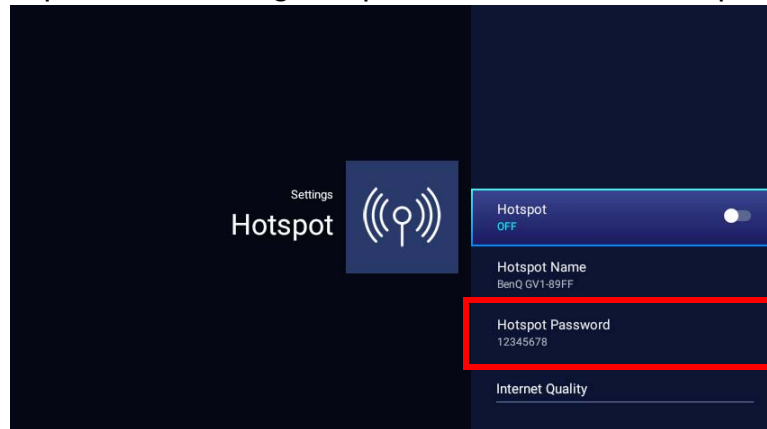

 The **Hotspot Name** and the **Hotspot Password** can only be changed when **Hotspot** is disabled.

5. Select **Hotspot** and press **OK** to enable Wi-Fi hotspot.

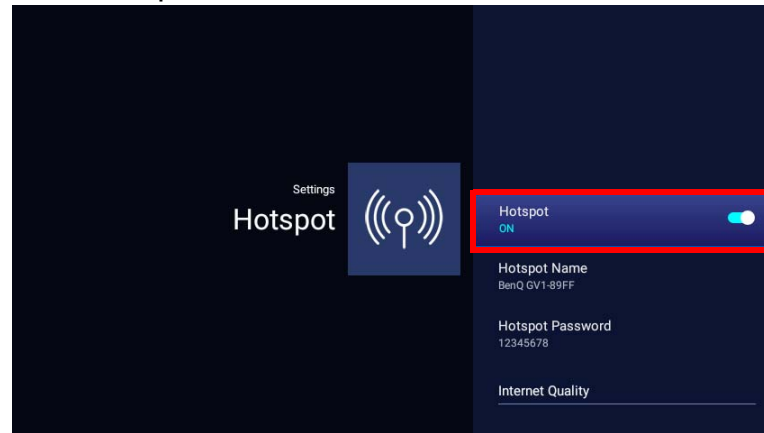

6. Once Wi-Fi hotspot is enabled, use the name shown in the **Hotspot Name** field as the SSID to connect to from your mobile device's Wi-Fi menu and use the password shown in the **Hotspot Password** field as the connection password.

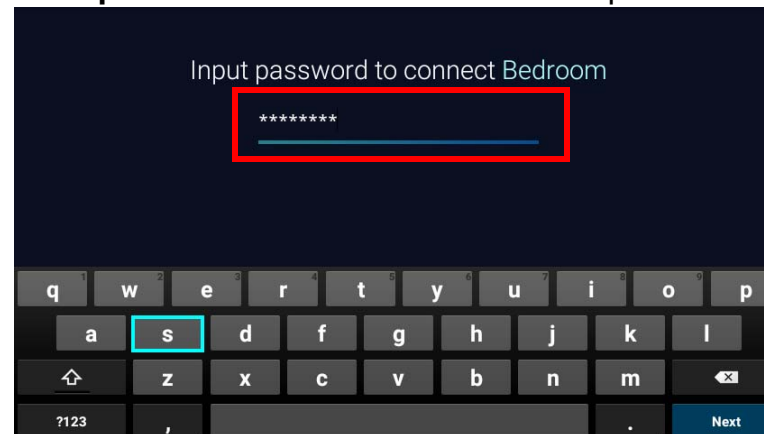



7. If the Wi-Fi hotspot can not be found by your device, select **Normal(2.4G)** under the **Internet Quality** heading.

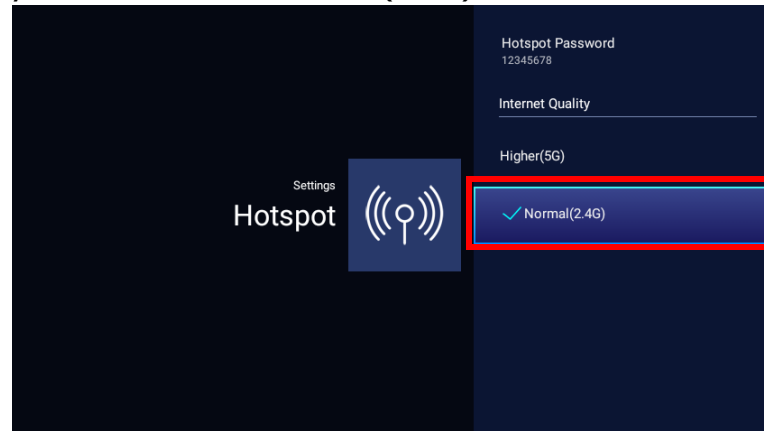

After the Wi-Fi hotspot is setup, follow the corresponding connection instructions described in the previous section(s) to connect to the projector directly and project video.

# Wired Connections

## Connecting a USB-C™ device with DisplayPort

Using the USB-C™ cable provided (or another USB-C™ Gen3.1 cable), you can connect a device that is equipped with DisplayPort capabilities to the projector in order to broadcast videos and images

- 
- Not all devices with a USB-C™ cable have DisplayPort functionality. Check your device's documentation for clarification.
  - If your device has a USB-C™ cable but not DisplayPort functionality, you can connect to the projector as a storage device. See [Connecting a USB-C™ device without DisplayPort on page 61](#)
- 

To connect a USB-C™ device with DisplayPort:

1. Connect the device to the USB-C™ port on the rear of the projector.
2. A pop-up notification will appear indicating that a device is connected to the projector. Select **OK** to connect to the device.

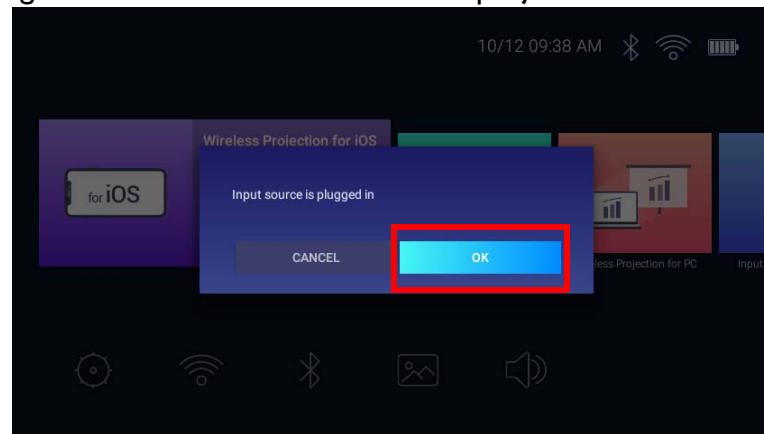

3. The projector will attempt to connect to the device's signal.

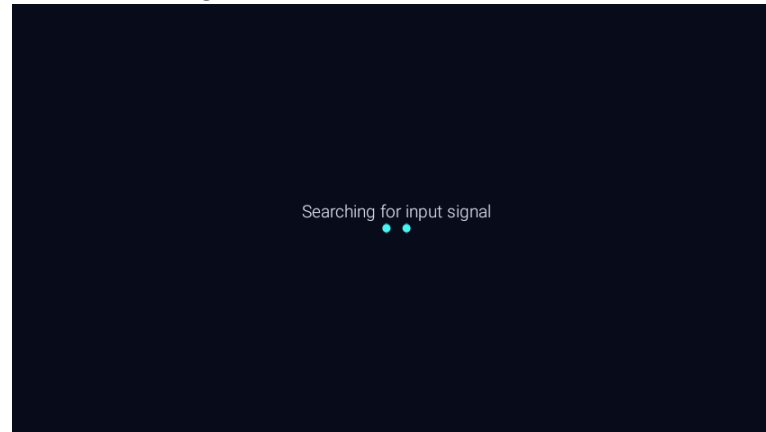

4. The video from the device will automatically be displayed full screen once the signal from the device is detected.

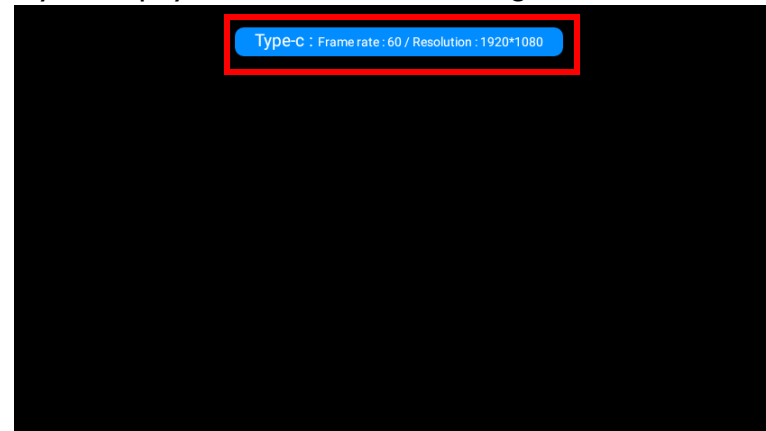

5. If no signal is detected or the signal is interrupted a message will appear:

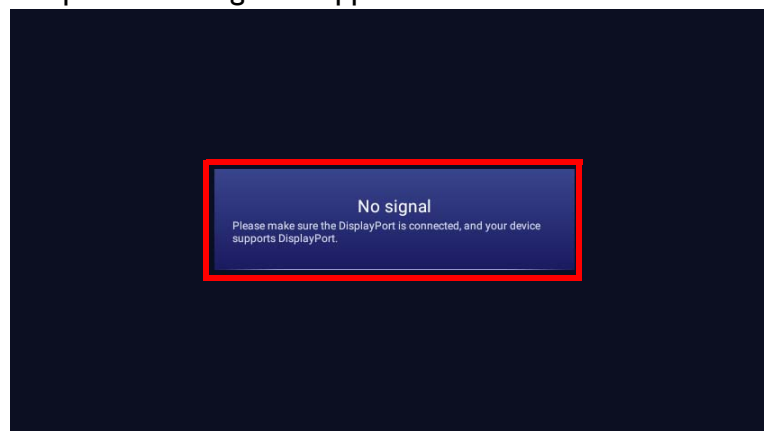

6. Press  $\rightarrow$  to stop the broadcast and return to the previously displayed menu, or press  $\square$  to exit and go back to the **BenQ Launcher** home screen directly.
7. If the device remains connected and you wish to display its signal again, navigate to the **Input Source** button on the **BenQ Launcher** home screen and press **OK**. Select the device and press **OK**.

- 
-  • If you want to use your USB-C™ device as a storage device to view videos, images and audio, then see [Media Player on page 63](#).
- Many laptops do not turn on their external video ports when connected to a projector. Usually a key combination like **Fn + F3** or CRT/LCD key turns the external display on/off. Locate a function key labeled CRT/LCD or a function key with a monitor symbol on the laptop. Press **Fn** and the labeled function key simultaneously. Refer to your laptop's documentation to discover your laptop's key combination.
-

## Connecting a USB-C™ device without DisplayPort

If you connect a device with a USB-C™ port that does not support DisplayPort, the projector will recognize it as a storage device and its media files can be accessed accordingly.

---

 Not all devices with a USB-C™ port have DisplayPort functionality. Check your device's documentation for clarification.

---

To connect a USB-C™ device without DisplayPort:

1. Connect the device to the USB-C™ port on the rear of the projector.
2. A pop-up notification will appear indicating that a device is connected to the projector. Select **OK** to search for signal.

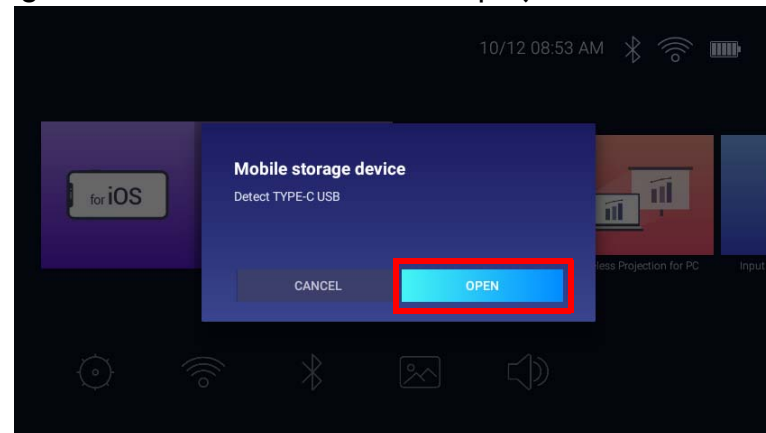

3. The **Media Player** will launch automatically. For more information on viewing files on **Media Player** see [Media Player on page 63](#).

## Connecting a USB-C™ flash drive

Connect a USB-C™ flash drive to the USB port on the rear of the projector to view media files stored on the flash drive.



You can also use devices with a USB-C™ port as a storage device. See [Connecting a USB-C™ device without DisplayPort on page 61](#)

---

To connect a USB-C™ flash drive

1. Connect the flash drive to the USB-C™ port on the rear of the projector.
2. A pop-up notification will appear indicating that a storage device is connected to the projector. Select **OPEN** to open the device.

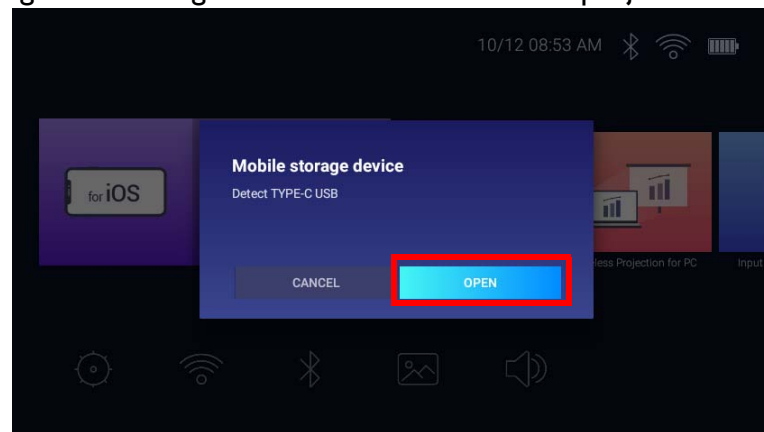

3. The **Media Player** will launch automatically. For more information on viewing files on **Media Player** see [Media Player on page 63](#).

## Media Player

The **Media Player** on the **BenQ Launcher** interface allows you to access images, videos, and audio files for projection once a USB-C™ flash drive or mobile device without DisplayPort capabilities is connected. See [Connecting a USB-C™ device without DisplayPort on page 61](#) and [Connecting a USB-C™ flash drive on page 62](#) for more information on connecting such devices to the projector.

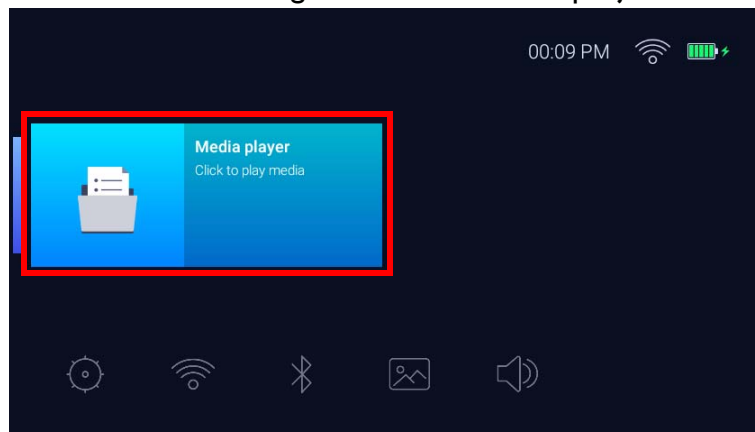

- 
- Once a storage device is connected to the projector, a notification will be displayed asking if you want to open the device. Select **OPEN** to be automatically directed to **Media Player** or select **CANCEL** to remain on the current screen.
  - See [Supported file formats on page 96](#) for a list of what file formats can be played on the projector.
- 

## Navigation

- Use the arrow keys (▲/▼/◀/▶) on your remote control to navigate to the file or icon you wish to select.
- Press **OK** to select a menu or file.
- Press ↵ to return to the previously displayed menu or to exit out of playing a media file.

The **Media Player** will show selections for your connected devices.

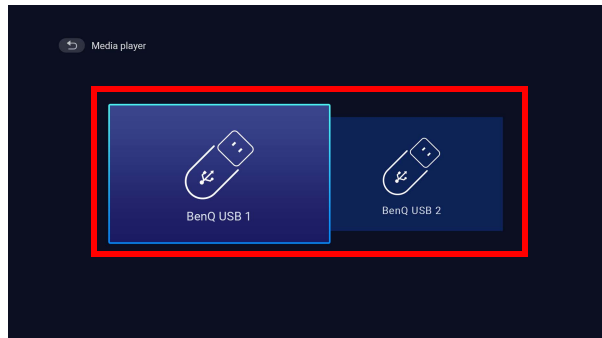

Each selection has a sub-directory that lists files for each of the following categories: **All**, **Video**, **Picture** and **Audio**.

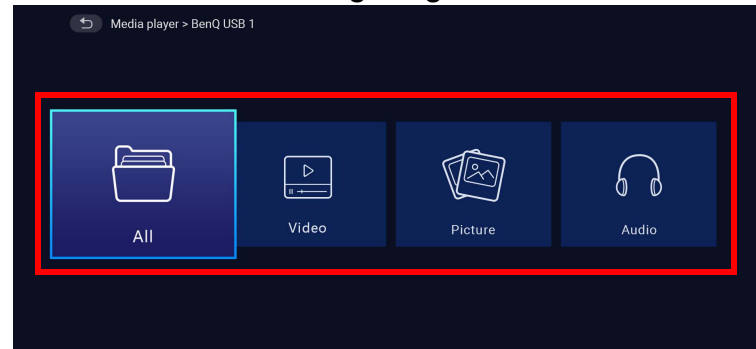

---

 If no supported media files are on the connected device then a message "**Not Available**" will appear.

---



## Using the **Media Player** to play video files:

1. Select **Video** in the sub-directory list for the connected device and press **OK**.

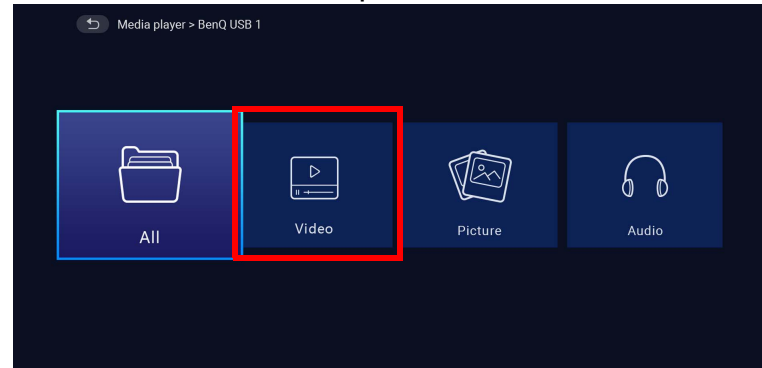



2. Use the up and down arrow keys (▲/▼) to choose the video file to be displayed and press **OK**.



3. The video file will begin playing.

4. In the viewing window you can choose one of the following options:

- Press the **OK** key on the  button to pause the video. Press it again to resume playing.
- Press the **OK** key on the  button to rewind the video.
- Press the **OK** key on the  button to fast forward the video.

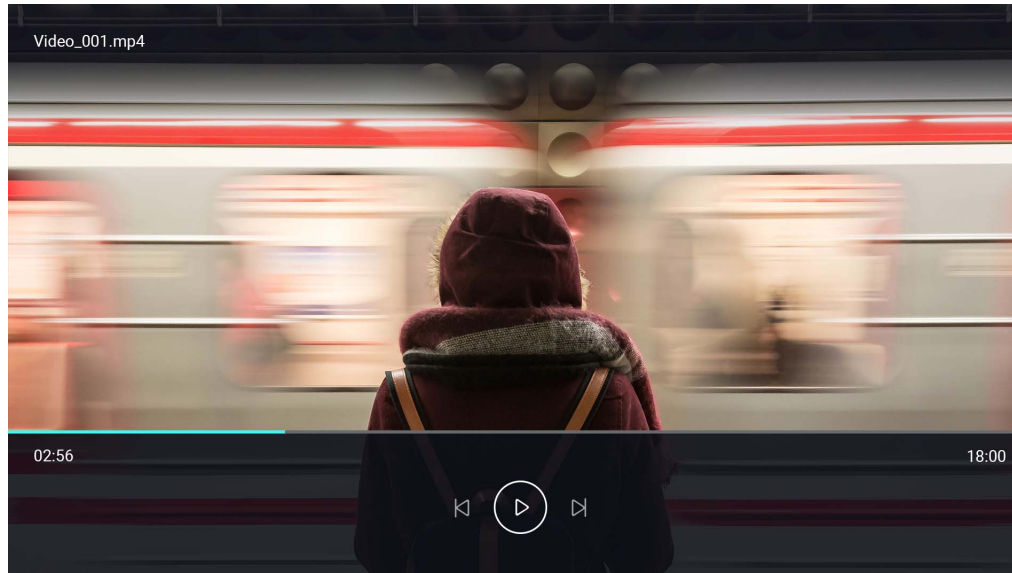

5. If the video file was played previously, a pop-up notification will appear asking to resume play or start over.

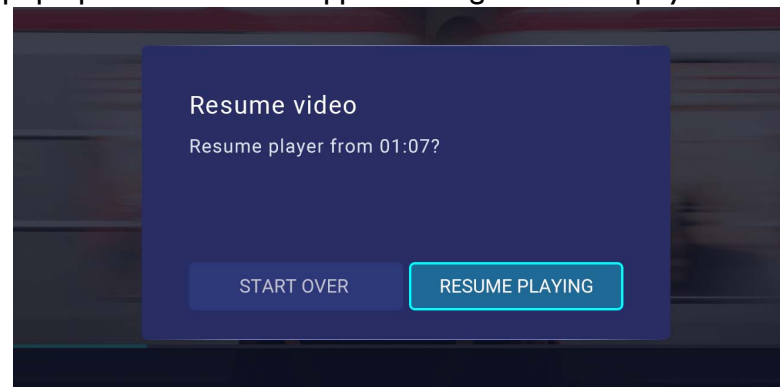

## Using the **Media Player** to play image files:

1. Select **Picture** in the sub-directory list for the connected device and press **OK**.

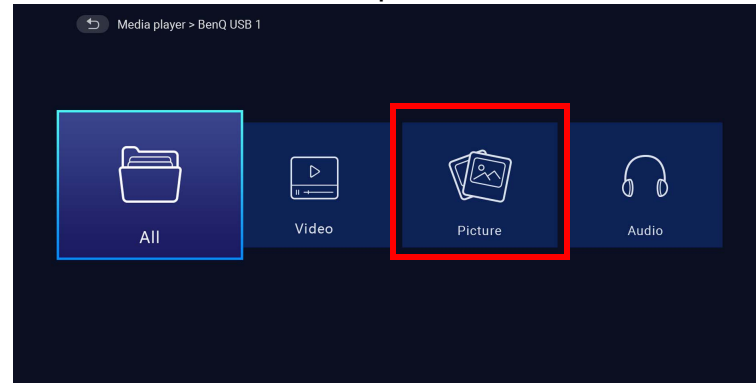

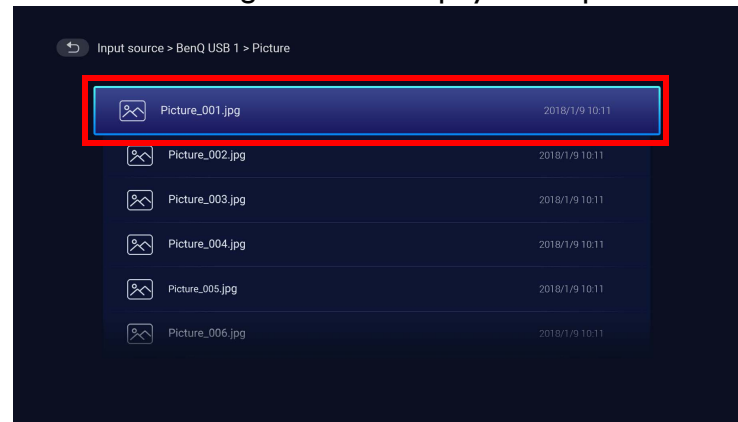

2. Use the up and down arrow keys (**▲/▼**) to choose the image file to be displayed and press **OK**.



3. The image file will be displayed.

4. In the viewing window you can choose one of the following options:

- Press the **OK** key on the  button to stop playing the playlist.
- Press the **OK** key on the  button to play the previous image in the playlist.
- Press the **OK** key on the  button to play the next image on the playlist.

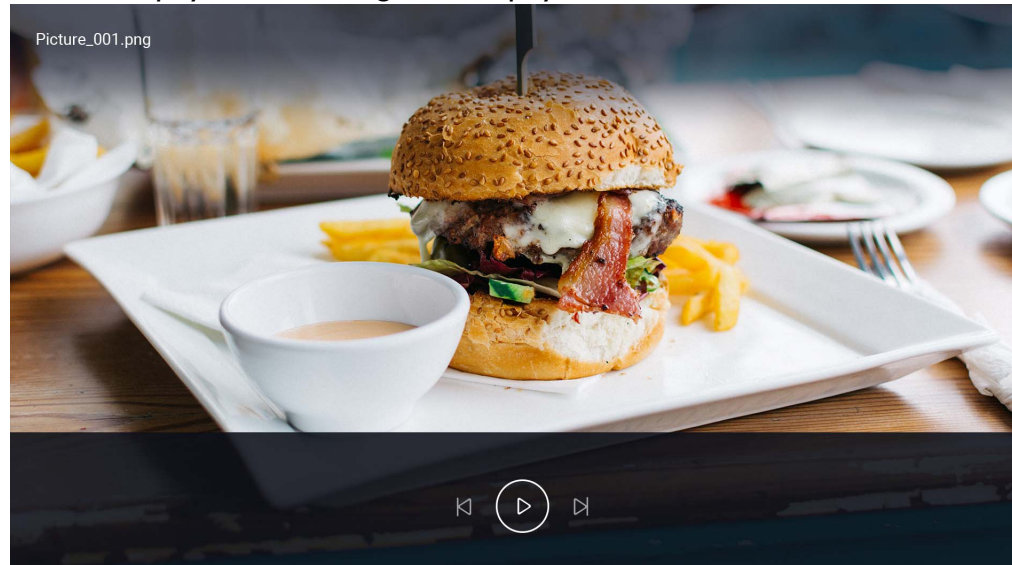

## Using the **Media Player** to play audio files:

1. Select **Audio** in the sub-directory list for the connected device and press **OK**.

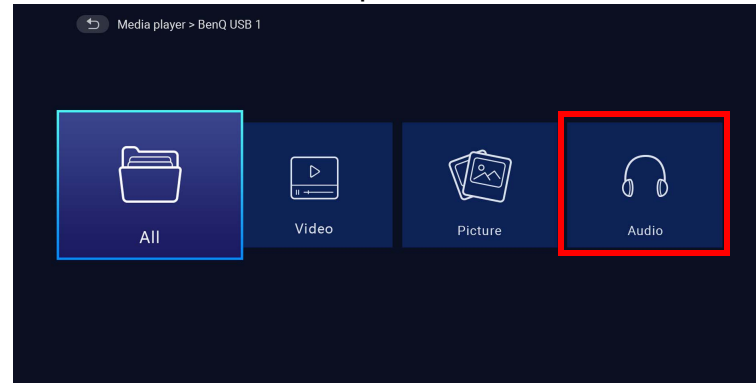



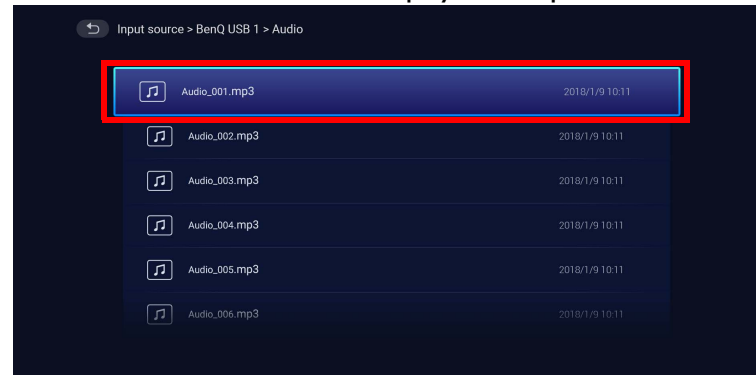





2. Use the up and down arrow keys (**▲/▼**) to choose the audio file to be played and press **OK**.





3. The audio file will begin playing.

4. In the viewing window you can choose one of the following options:

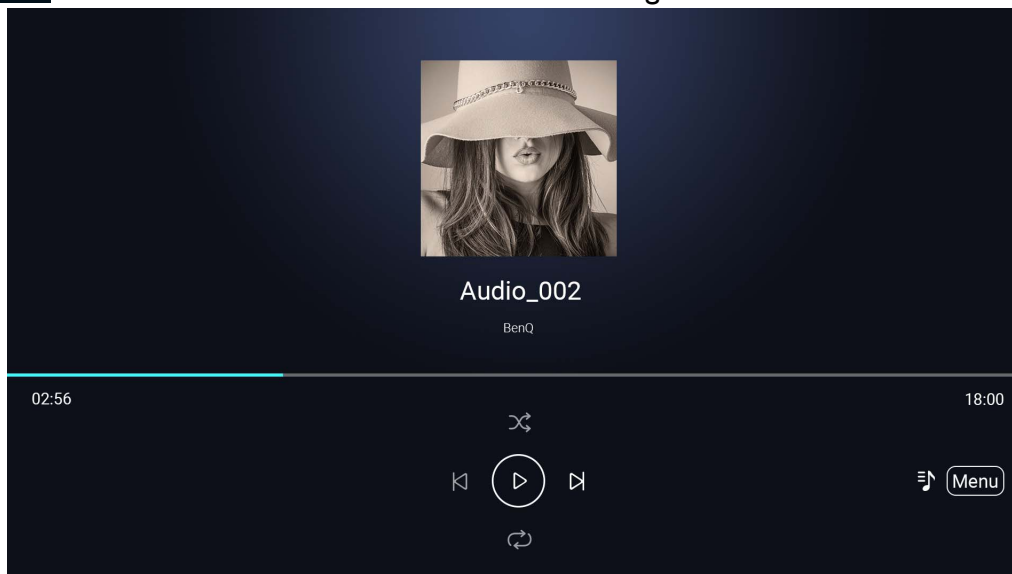
- Press the **OK** key on the  button to start or stop playing the audio file.
- Press the **OK** key on the  button to play the previous audio file in the playlist.
- Press the **OK** key on the  button to play the next audio file on the playlist.
- Press and hold the left arrow key (◀) on the  button to rewind through an audio track.
- Press and hold the right arrow key (▶) on the  button to fast forward through an audio track.
- Press the **OK** key on the  button to randomly play all audio files on the playlist. Press **OK** again to turn shuffle mode off.
- Press the **OK** key on the  button to repeat the playlist on a loop. Press the **OK** key again to repeat playing the current audio file . Press **OK** again to turn repeat mode off.
- Press the **OK** key on the  button to return to the album where the song is listed.



- You can play audio files in the background while playing an image slideshow. Select  while an audio file is playing in the audio player in order to return to the **Media Player** main menu to select an image file to play.
- The  button will only work if songs are organized in albums. If all songs are in one directory then it will have no function.

# Bluetooth Connections

The projector allows the following types of Bluetooth connections:

- Connect to a Bluetooth-enabled speaker or headphones to output audio directly for greater sound particularly in outdoor settings.
- Connect a mobile device to the projector to broadcast audio through the projector's speakers

## Pairing/Connecting to a Bluetooth speaker or headphones

Pairing is the process by which your projector creates a connection to a Bluetooth speaker or headphones for the first time. Once both devices have been successfully paired each device will have the corresponding device's pairing information stored internally and both will be able to connect automatically when they are within a ~8 meter range of each other and Bluetooth is enabled on the projector.

To pair your projector to a Bluetooth speaker or headphones:

1. Power on the projector.
2. Press the down arrow key ▼ on the remote control to navigate to the settings menus.
3. Select **Bluetooth** and press **OK**.
4. Select **Bluetooth** and press **OK** to enable Bluetooth.

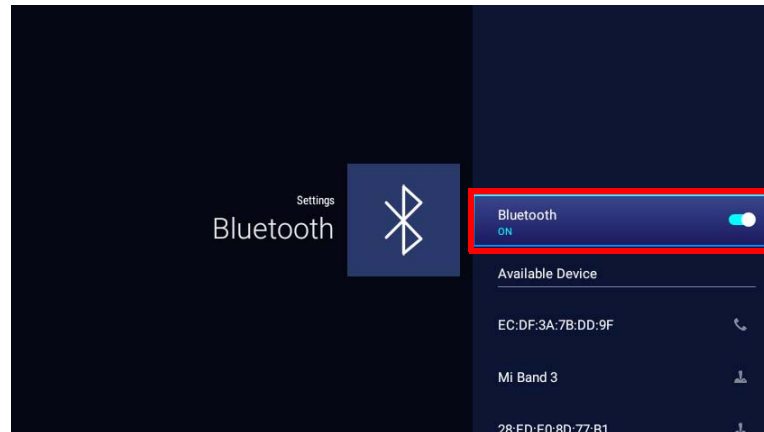

5. Activate Bluetooth-pairing mode on the speaker or headphones.

6. Select the speaker or headphones from the **Available Device** list and in the **Bluetooth** setting menu press **OK**.

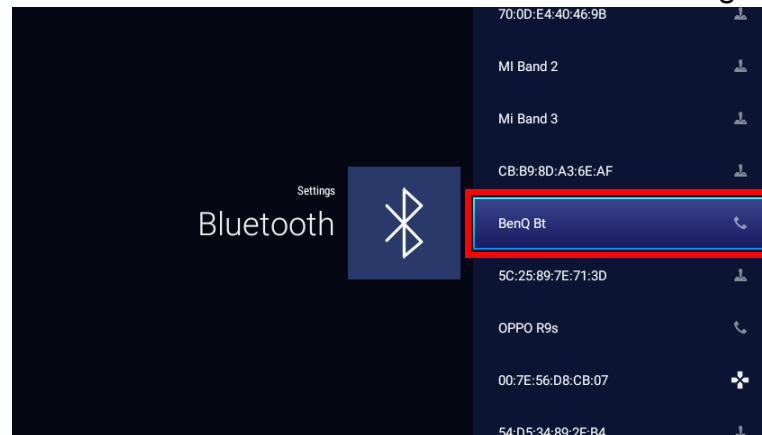

7. When the projector and speaker or headphones have successfully connected the device listing in the Bluetooth setting menu will be labeled **Connected**, you can now output the audio from the projector to the speaker or headphone.

Once you have successfully paired your projector with the Bluetooth speaker, pairing information will be stored on both devices and a connection will automatically be made when Bluetooth is enabled on both devices and both devices are within range of each other.

## Ending the Bluetooth connection

In cases where you want to disconnect a speaker or headphones from the projector and connect to another speaker or headphones follow the steps below:

1. Press the down arrow key ▼ on the remote control to navigate to the settings menus.
2. Select **Bluetooth** and press **OK**.
3. Select the already connected speaker or headphones from the **Available Device** list in the **Bluetooth** setting menu and press **OK**.
4. Confirm that you want to disconnect the speaker or headphones from the projector.
5. Activate Bluetooth-pairing mode on the new speaker or headphones.
6. Select the new speaker or headphones from the **Available Device** list in the **Bluetooth** setting menu and press **OK**.

---

 If you are unable to find the speaker or headphones from the list of Bluetooth devices on the first try, ensure that pairing mode is activated on the device, then select **Scan for devices** in the Bluetooth setting menu to restart the scanning process.

---



## Deactivating the Bluetooth speaker or headphones

To deactivate Bluetooth on the projector so that it no longer outputs its audio to a separate speaker or headphones:

1. Press the down arrow key ▼ on the remote control to navigate to the settings menus.
2. Select **Bluetooth** and press **OK**.
3. Select **Bluetooth** and press **OK** to disable Bluetooth.

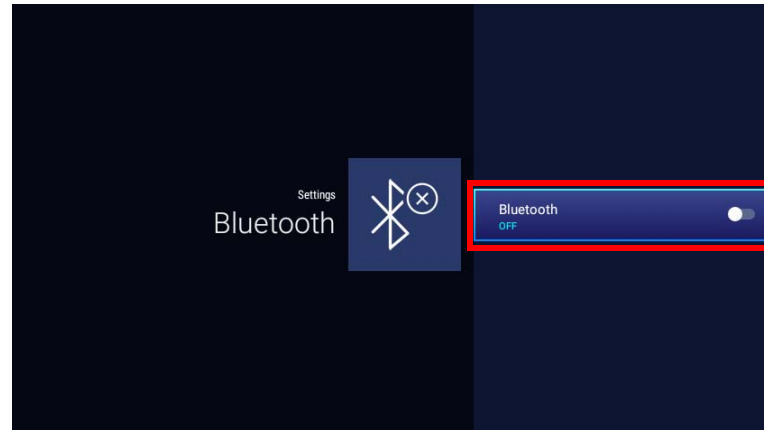

## Using the Projector as a Bluetooth speaker

To connect a mobile device to the projector and use the projector as a Bluetooth speaker:

1. Press the switch mode key ⇄ on the projector, a screen will be shown by the projector indicating that it is switching to Bluetooth mode.
2. The projector lamp on the projector will shut off and the switch mode LED indicator will begin flashing blue.
3. Enable Bluetooth on your mobile device.
4. Select the BenQ GVI device name from the list of available devices on your mobile device.
5. Once your mobile device has successfully paired and connected to the projector the projector will play a connection sound and the switch mode LED indicator will light up solid blue.

Once you have successfully paired your mobile device with the projector, pairing information will be stored on both devices and a connection will automatically be made when Bluetooth is enabled on both devices and both devices are within range of each other.

## Ending the Bluetooth connection

In cases where you want to disconnect the mobile device from the projector either:

- Disconnect from the projector in the Bluetooth menu of your mobile device.
- Press the switch mode key  $\Leftrightarrow$  on the projector to return the projector to projector mode.

# Navigating the **Settings** menu

## About the **Settings** menu

To let you make various adjustments or settings on the projector, its wireless connections, and the projected image, **BenQ Launcher** provides a **Settings** menu. Under the **Settings** menu are menus for various settings.

To access the **Settings** menu, in the **BenQ Launcher** home page press the down button ▼ on your remote control, and then select **Settings**.

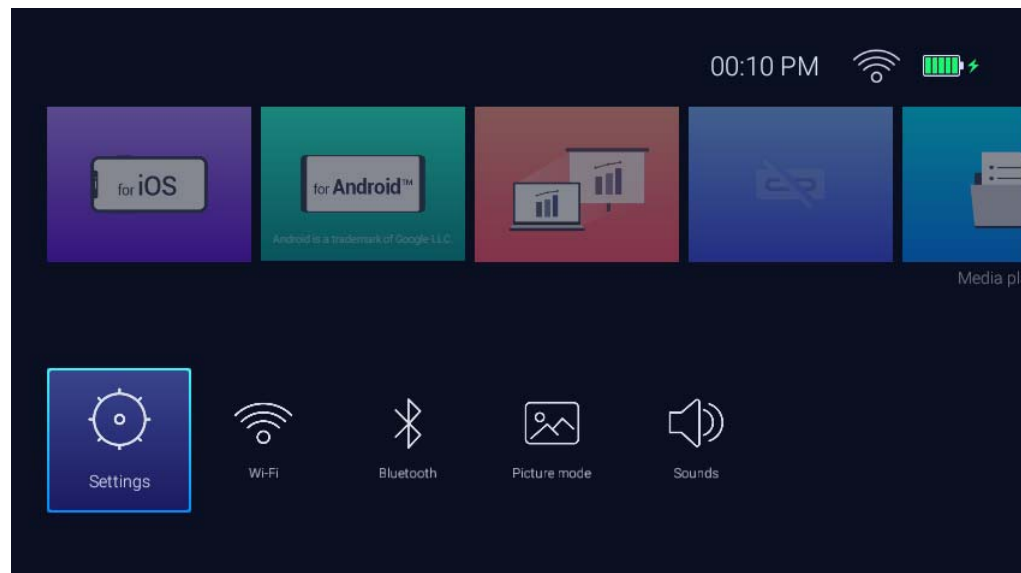
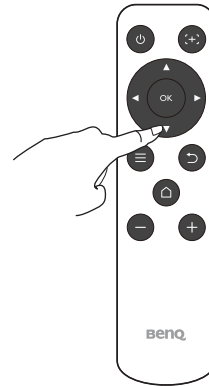

The following is the **Settings** menu:

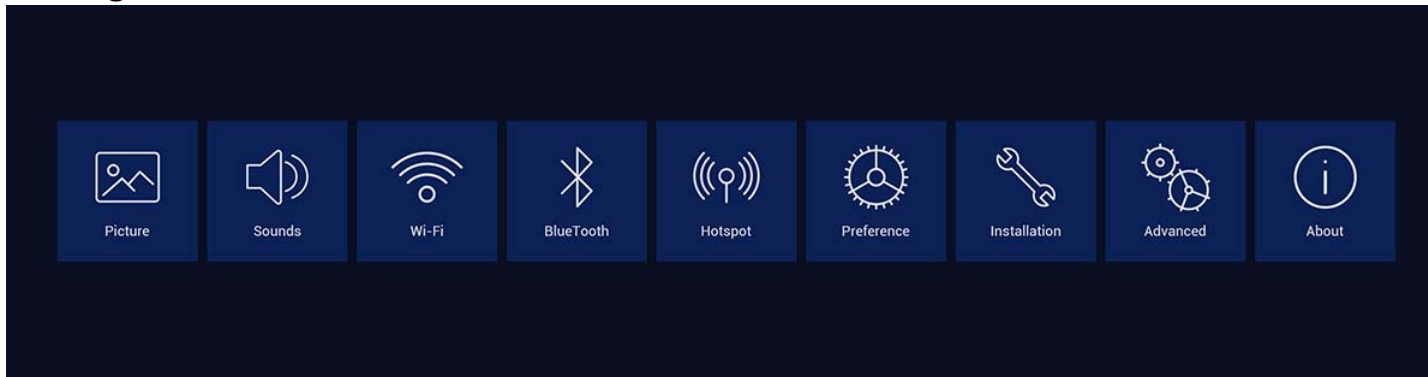

## Using the **Settings** menu

To access the various settings menus:

- Use the left and right arrow keys (◀/▶) to move through the main settings menus.
- Use **OK** to select the desired menu.

When configuring items within a menu:

- Use the up and down arrow keys (▲/▼) to move to the item you want to configure.
- Use left and right arrow keys (◀/▶) to toggle through the available options.
- Use **OK** to enable/disable options or select sub-menu options.
- Use the back button ↶ to return to the main settings menu.
- Use the home button ◻ to return to the **BenQ Launcher** home page.

# Picture

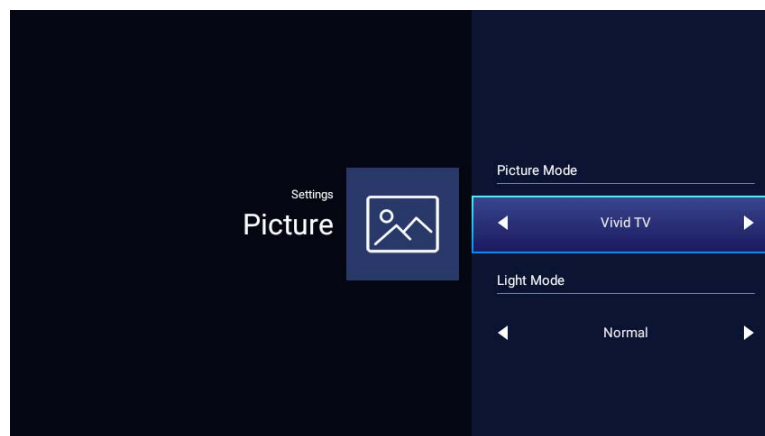

The following table describes the items available in the **Picture** menu:

Item	Options and descriptions	
<b>Picture Mode</b>	Selects a preset picture mode to suit your operating environment and input signal picture type. The preset picture modes are described as below:	
	<b>Bright</b>	Maximizes the brightness of the projected image. This mode is suitable for environments where extra-high brightness is required, such as using the projector in well lit rooms.
	<b>Presentation</b>	Designed for presentations. The brightness is emphasized in this mode to match PC and notebook coloring.
	<b>Vivid TV</b>	Being slightly brighter than <b>Cinema</b> mode, it is suitable for playing movies in rooms where there is a small amount of ambient light, e.g. your living room.
	<b>Cinema</b>	Well-balanced color saturation and contrast with a low brightness level, this mode is most suitable for enjoying movies in a totally dark environment (as you would find in a commercial cinema).
	<b>Sport</b>	This mode is best for watching sporting events in rooms where is a small amount of ambient light, eg. your living room.

Item	Options and descriptions	
<b>Light Mode</b>	Selects the projector lamp power from the following modes.	
	<b>Normal</b>	Provides full lamp brightness.
	<b>Eco Mode</b>	Reduces system noise and power consumption by 30%. If <b>Eco Mode</b> mode is selected, the light output will be reduced and result in darker projected pictures.
	<b>Battery Mode</b>	<p>Reduces system noise and power consumption to fulfill 3 hours projection*. If <b>Battery Mode</b> is selected, the light output will be reduced and result in darker projected pictures. And the picture mode will lock at <b>Cinema</b> mode.</p> <p>*The 3 hours of projection is under the following settings:</p> <ul style="list-style-type: none"> <li>• <b>Light Mode: Battery Mode</b></li> <li>• <b>Picture Mode: Vivid TV</b> mode</li> <li>• Audio volume: 50% and playing from GVI</li> <li>• <b>Bluetooth: On</b>, but not connected to other device</li> <li>• <b>Wi-Fi: On</b> and connected.</li> </ul>

# Sounds

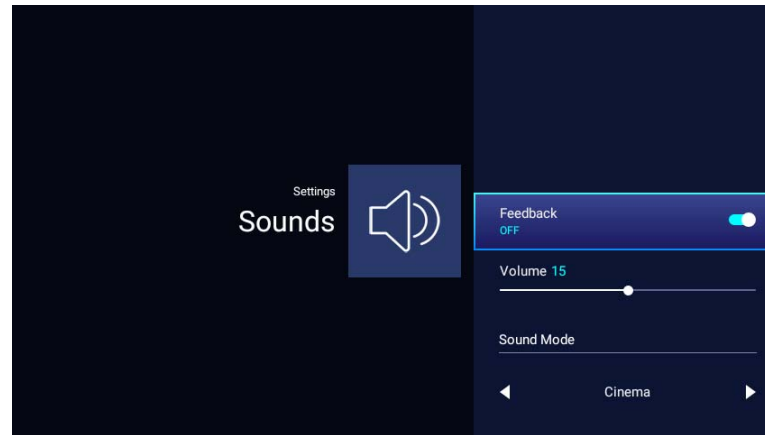

The following table describes the items available in the **Sounds** menu

Item	Options and descriptions
<b>Feedback</b>	Enables/Disables feedback on the audio provided by the projector.
<b>Volume</b>	Adjusts the sound level for the projector.
<b>Sound Mode</b>	Utilizes sound enhancement technology, which incorporates Waves' algorithms to deliver great effects of the bass and treble and provide you with immersive cinematic audio experience. The following preset sound modes are provided: <b>Standard, Cinema, Music, Game, and Sport.</b>

# Wi-Fi

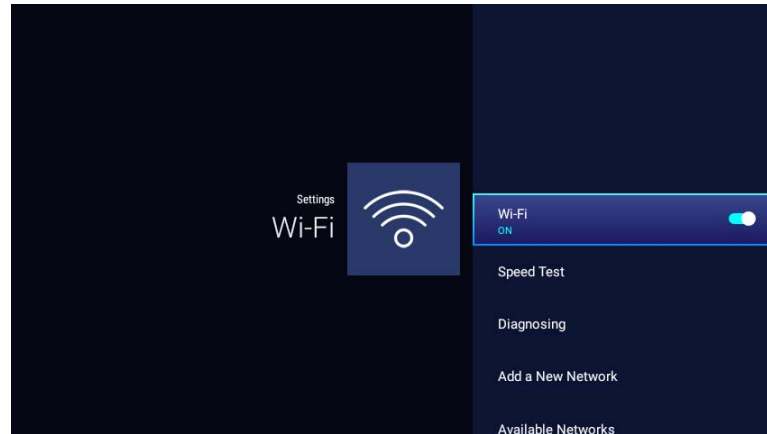

The following table describes the items available in the **Wi-Fi** menu

Item	Options and descriptions
<b>Wi-Fi</b>	Enables Wi-Fi for the projector. See <a href="#">Connecting the projector to a Wi-Fi network on page 45</a> for details.
<b>Speed Test</b>	Tests the speed of the projector's Internet connection.
<b>Diagnosing</b>	Diagnoses the status of the projector's Internet connection.
<b>Add a New Network</b>	Allows you to add a specific network that may be hidden or undetected in the <b>SSID List</b> . Once selected you will be prompted to enter the SSID and security settings for the network.
<b>SSID List</b>	Lists the available Wi-Fi access points which the projector can connect to. See <a href="#">Connecting the projector to a Wi-Fi network on page 45</a> for details.  The <b>SSID List</b> is only available when <b>Wi-Fi</b> is enabled.



# Bluetooth

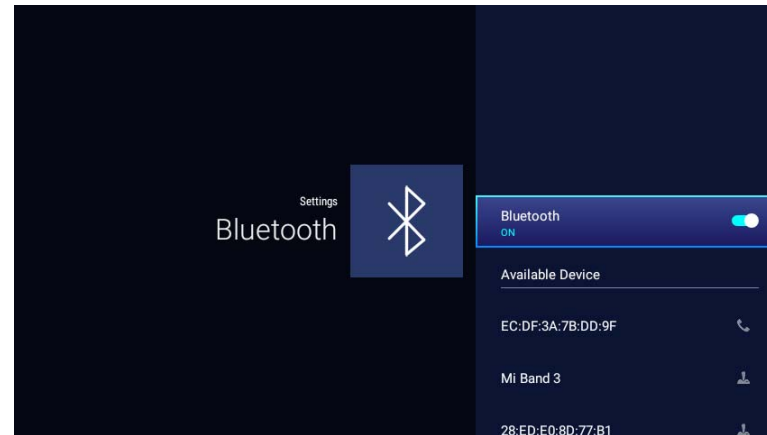



The following table describes the items available in the **Bluetooth** menu

Item	Options and descriptions
<b>Bluetooth</b>	Enables Bluetooth for the projector, allowing the projector to output its audio to a Bluetooth speaker or headphones.
<b>Available Device</b>	Lists the available Bluetooth devices which the projector can pair and connect to. Select <b>Scan for devices</b> if you want to refresh the list of devices.  The <b>Available Device</b> is only available when <b>Bluetooth</b> is enabled.

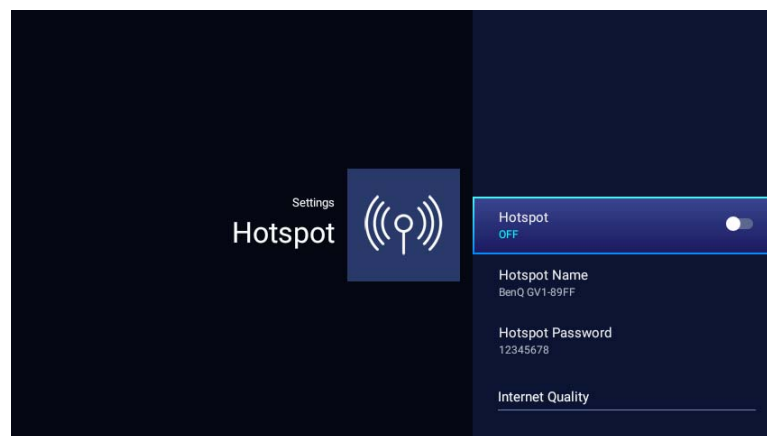
# Hotspot



The following table describes the items available in the **Hotspot** menu

Item	Options and descriptions
<b>Hotspot</b>	Enables Wi-Fi hotspot for the projector, allowing other devices to connect to the projector directly. See <a href="#">Wi-Fi Hotspot on page 54</a> for details.
<b>Hotspot Name</b>	Sets the name for the projector's Wi-Fi hotspot, which appears in the Wi-Fi list for devices looking to connect directly to the projector.  The default name for the projector's Wi-Fi hotspot is " <b>BenQ PRJ GVI</b> ".
<b>Hotspot Password</b>	Sets the password for the projector's Wi-Fi hotspot.  The password needs to be 8 characters.
<b>Internet Quality</b>	Sets the frequency for the projector's Wi-Fi hotspot signal. Available options include <b>2.4G</b> and <b>5G</b> .  The default frequency is set to <b>5G</b> , certain mobile devices may not be able to connect via a <b>5G</b> . In such instances set the <b>Internet Quality</b> to <b>2.4G</b> .

# Installation

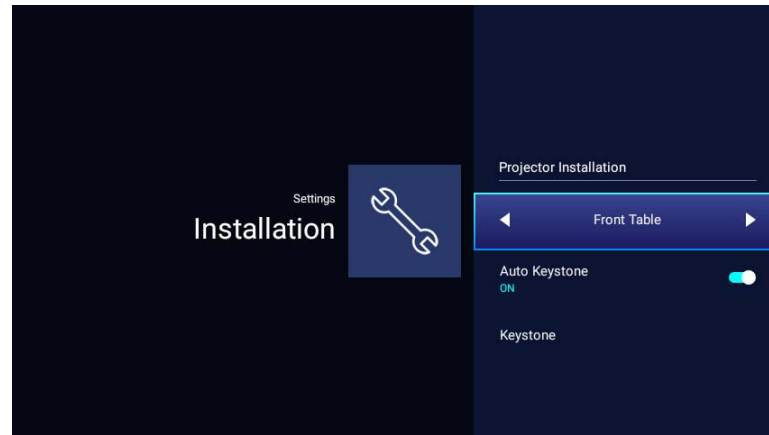

The following table describes the items available in the **Installation** menu

Item	Options and descriptions	
<b>Projector Installation</b>	The projector can be installed in a high location or behind a screen. See <a href="#">Choosing a location on page 25</a> for details.	
	<b>Front Table</b>	Select this location with the projector placed near the floor in front of the screen.
	<b>Front Ceiling</b>	Select this location with the projector elevated near the ceiling in front of the screen.
	<b>Rear Table</b>	Select this location with the projector placed near the floor behind the screen.
	<b>Rear Ceiling</b>	Select this location with the projector elevated from the ceiling behind the screen.
<b>Auto Keystone</b>	Enable this function to allow the projector to automatically adjust the keystone settings when powered on. See <a href="#">Correcting keystone on page 38</a> for more details.	
<b>Keystone</b>	Adjusts the keystone settings for the projected image. See <a href="#">Correcting keystone on page 38</a> for more details.  This function is only available when <b>Auto Keystone</b> is disabled.	

## Preference

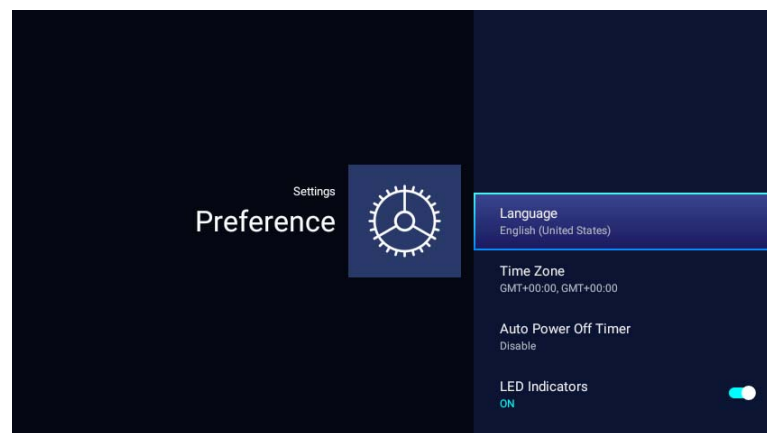

The following table describes the items available in the **Preference** menu

Item	Options and descriptions
<b>Language</b>	Sets the language for <b>BenQ Launcher</b> .
<b>Time Zone</b>	Sets the time zone for the projector.
<b>Auto Power Off Timer</b>	Sets the time interval in which the projector will automatically power off when inactive. The following <b>Auto Power Off Timer</b> options are provided: <b>Disable, 5 mins, 10 mins, 15 mins, 20 mins, 25 mins, and 30 mins.</b>
<b>LED Indicators</b>	You can turn off the LED warning lights. This is to avoid any light disturbance when viewing images in a dark room.

## About

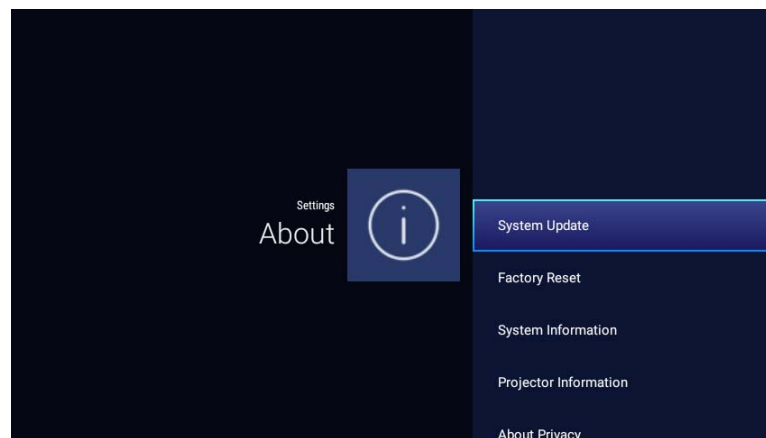

The following table describes the items available in the **About** menu

Item	Options and descriptions
<b>System Update</b>	Displays the software version and allows you to update the software over Wi-Fi or directly via a USB flash drive.
<b>Factory Reset</b>	Returns all settings to the factory preset values.
<b>System Information</b>	Displays hardware/firmware information for the projector including its model name, operating system version, memory, storage capacity, serial number, and MAC address.
<b>Projector Information</b>	Displays information on the current status of the projector including the current <b>Picture Mode</b> , <b>Light Mode</b> , <b>Detected Resolution</b> , <b>Native Resolution</b> , and <b>Firmware Version</b> .
<b>About Privacy</b>	Displays the BenQ privacy announcement.

# Maintenance

## Care of the projector

Your projector needs little maintenance. The only thing you have to do on a regular basis is keep the lens clean.

Never remove any parts of the projector. Contact your dealer or local customer service center if the projector fails to operate as expected.

## Cleaning the lens

Clean the lens whenever you notice dirt or dust on the surface.

Before cleaning any part of the projector, turn it off using the proper shutdown procedure (see [Shutting down the projector on page 35](#)), unplug the power cable, and let it cool down completely.

- Use a canister of compressed air to remove dust.
- If there is dirt or smears, use lens-cleaning paper or moisten a soft cloth with lens cleaner and gently wipe the lens surface.
- Never use any type of abrasive pad, alkaline/acid cleaner, scouring powder, or volatile solvent, such as alcohol, benzene, thinner or insecticide. Using such materials or maintaining prolonged contact with rubber or vinyl materials may result in damage to the projector surface and cabinet material.

---

 Never touch the lens with your finger or rub the lens with abrasive materials. Even paper towels can damage the lens coating. Only ever use a proper photographic lens brush, cloth, and cleaning solution. Do not attempt to clean the lens while the projector is switched on or is still hot from previous use.

---

## Storing the projector

To store the projector for an extended time:

- Make sure the temperature and humidity of the storage area are within the recommended range for the projector. Refer to Specifications or consult your dealer about the range.
- Retract the adjuster feet.
- Remove the batteries from the remote control.
- Pack the projector in its original packing or equivalent.

## Transporting the projector

It is recommended that you ship the projector with its original packing or equivalent.

## Extending LED life

The projection LED is an 200AL LED bulb which features a light-source life far beyond traditional bulbs, yet it is still a consumable item. To keep the lamp life as long as possible, you can change the following settings via the settings menu.

To access the settings menu, see [Using the Settings menu on page 76](#) for details.

## Setting LED Mode

Setting the projector in **Eco Mode** extends the lamp life.

LED mode	Description
<b>Normal</b>	100% lamp brightness
<b>Eco Mode</b>	<b>Eco Mode</b> reduces system noise and power consumption by 30%. If <b>Eco Mode</b> is selected, the light output will be reduced and result in darker projected pictures.
<b>Battery Mode</b>	<b>Battery Mode</b> reduces system noise and power consumption to fulfill 3 hours projection*. If <b>Battery mode</b> is selected, the light output will be reduced and result in darker projected pictures. And the picture mode will lock at Cinema Mode.  *The 3 hours of projection is under the following settings: <ul style="list-style-type: none"><li>• <b>Light Mode: Battery Mode</b></li><li>• <b>Picture Mode: Vivid TV mode</b></li><li>• Audio volume: 50% and playing from GVI</li><li>• <b>Bluetooth: On</b>, but not connected to other device</li><li>• <b>Wi-Fi: On</b> and connected.</li></ul>

1. Select **Settings > Picture > Light Mode**.
2. Press (◀/▶) to move to your desired mode.
3. When done, press to ↵ your changes and exit.

## Setting Auto Power Off

This function allows the projector to turn off automatically if no action is detected after a set period of time.

1. Select **Settings > Preference > Auto Power Off Timer** and press **OK**.
2. Press (▲/▼) to select a time period. If the preset time lengths are not suitable for your presentation, select **Disable**, and the projector will not automatically shut down.
3. When done, press to ↵ to save your changes and exit.



# Troubleshooting

Problem	Cause	Remedy
The projector does not turn on.	There is no power from the power cable.	Plug the power cable into the AC inlet on the rear of the projector, and plug the power cable into to the power outlet. If the power outlet has a switch, make sure that it is switched on.
	Attempting to turn the projector on again during the cooling process.	Wait until the cooling down process has completed.
	The battery is running out and in low voltage.	Plug in power adapter to charge it for a while, then press and hold the power key on the projector for 3 seconds to turn it on.
No input source.	The video source is not turned on or connected correctly.	Turn the video source on and check that the signal cable is connected correctly.
	The projector is not correctly connected to the input source device.	Check the connection. Please also make sure your device supports DisplayPort and is connected by USB-C™ Gen 3.1 cable.
	The video or audio file format is not supported by the projector.	Make sure the supported file format as described in <a href="#">Supported file formats on page 96</a> is being played, or contact the customer service for assistance.

Problem	Cause	Remedy
Image or audio is unstable.	The connection cables are not securely connected to the projector or the signal source.	Correctly connect the cables to the appropriate terminals.
	The Internet bandwidth is limited or over-occupied.	Connect to another Wi-Fi AP or to an Internet channel of better speed.
	The projector is out of effective range of Bluetooth connection.	Make sure the projector is within the effective range of Bluetooth connection. Make sure there is as less radio frequency interference as possible when using a 2.4G network.
Picture is blurred.	The projection lens is not correctly focused.	Adjust the focus of the lens using the focus ring.
	The projector and the screen are not aligned properly.	Adjust the projection angle and direction as well as the height of this projector if necessary.
Remote control does not work correctly.	The batteries are out of power.	Replace both of the batteries with new ones.
	There is an obstacle between the remote control and the projector.	Remove the obstacle.
	You are too far away from the projector.	Stand within 8 meters (26.2 feet) of the projector.

# Specifications

## Projector specifications



All specifications are subject to change without notice.

GVI Projector Specifications	
<b>Projection System</b>	DLP
<b>Native Resolution</b>	WVGA (854 x 480)
<b>Brightness</b>	200AL
<b>Contrast Ratio (FOFO)</b>	100,000:1
<b>Lens</b>	F=1.5, f=5.53mm
<b>Throw Ratio</b>	1.3 (35"@1M)
<b>SoC</b>	Qualcomm Snapdragon 210 MSM8909
<b>OS</b>	Android 7.1.2
<b>RAM</b>	1G LPDDR3
<b>Flash</b>	8G EMMC

GVI Projector Specifications		
<b>WLAN</b>	IEEE 802.11 a/b/g/n, 2.4G/5G	
<b>2.4G</b>	A SKU	Ch1-Ch11
	E SKU	
<b>5G</b>	A SKU	Band1: Ch36, Ch40, Ch44, Ch48
		Band4: Ch149, Ch153, Ch157, Ch161, Ch165
	E SKU	Band1: Ch36, Ch40, Ch44, Ch48
<b>Interface</b>	<ul style="list-style-type: none"> <li>• DC in x1</li> <li>• USB-C™ (DP Alt mode, Data) x1</li> </ul>	
<b>Dimensions</b>	80 x 155 x 80 mm	
<b>Weight</b>	708g	
<b>Working Temperature</b>	0°C-40°C	
<b>Working Altitude</b>	0 m - 2000 m	
<b>Power</b>	DC Supply	
	Frequency	AC 100 to 240 V, 50/60 Hz
	Power Rating	12V 2000mAh 24W
	Battery Life	
	Type	Lithium-ion Polymer
	Electrical Rating	7.4V 3000mAh 22.2W
	Battery Cycle Life	300 cycles
	Charging Time	3 hours from 0% to 100%
	Battery Life	3 hours in battery mode

## Dimensions

80 mm x 80 mm x 155 mm (W x D x H)

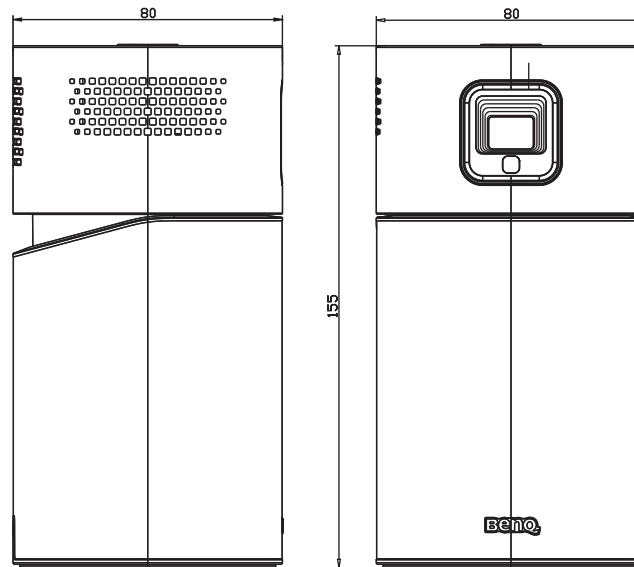

## Timing chart

### Supported timing for video input

Timing	Resolution	H. Frequency (KHz)	V. Frequency (KHz)	Dot Clock Frequency (MHz)
480p	720 x 480	31.47	59.94	27
576p	720 x 576	31.25	50	27
720/50p	1280 x 720	37.5	50	74.25
720/60p	1280 x 720	45.00	60	74.25
1080/24P	1920 x 1080	27	24	74.25
1080/25P	1920 x 1080	28.13	25	74.25
1080/30P	1920 x 1080	33.75	30	74.25
1080/50P	1920 x 1080	56.25	50	148.5
1080/60P	1920 x 1080	67.5	60	148.5

### Supported timing for PC input

Resolution	Mode	Refresh Rate (Hz)	H. Frequency (KHz)	Dot Clock Frequency (MHz)
640 x 480	VGA_60	59.940	31.469	25.175
800 x 600	SVGA_60	60.317	37.879	40.000
1024 x 768	XGA_60	60.004	48.363	65.000
1280 x 720	1280 x 720_60	60	45.000	74.250
1280 x 800	WXGA_60	59.810	49.702	83.500

Resolution	Mode	Refresh Rate (Hz)	H. Frequency (KHz)	Dot Clock Frequency (MHz)
1280 x 960	1280 x 960_60	60.000	60.000	108
1920 x 1080 @ 60Hz	1920 x 1080_60	60	67.5	148.5

---

 The timings showing above may not be supported for due to EDID file and VGA graphic card limitations. It is possible that some timings cannot be chosen.

---

## Supported file formats

File type	File extension
Documents	.txt
Photos	JPG(.jpg, .jpeg), PNG(.png), BMP(.bmp)
Music	MP3(.mp3), AAC(.aac)
Video	XVID(.avi) MPEG-4(3gp, mp4) H.263(3g2, .avi, .mkv, .webm, 3gp, mp4)
Subtitles	N/A



Bit rate range: If the peak bit rate of a video file is larger than 10MB, it might cause video playback lag.